

Cardan and double joints

Pin and block cardan shafts

Drive and driven flanges

Ball and socket cardan shafts

Single pieces and repair of universal joint shafts

ORIGINAL
elbe
GELENKE

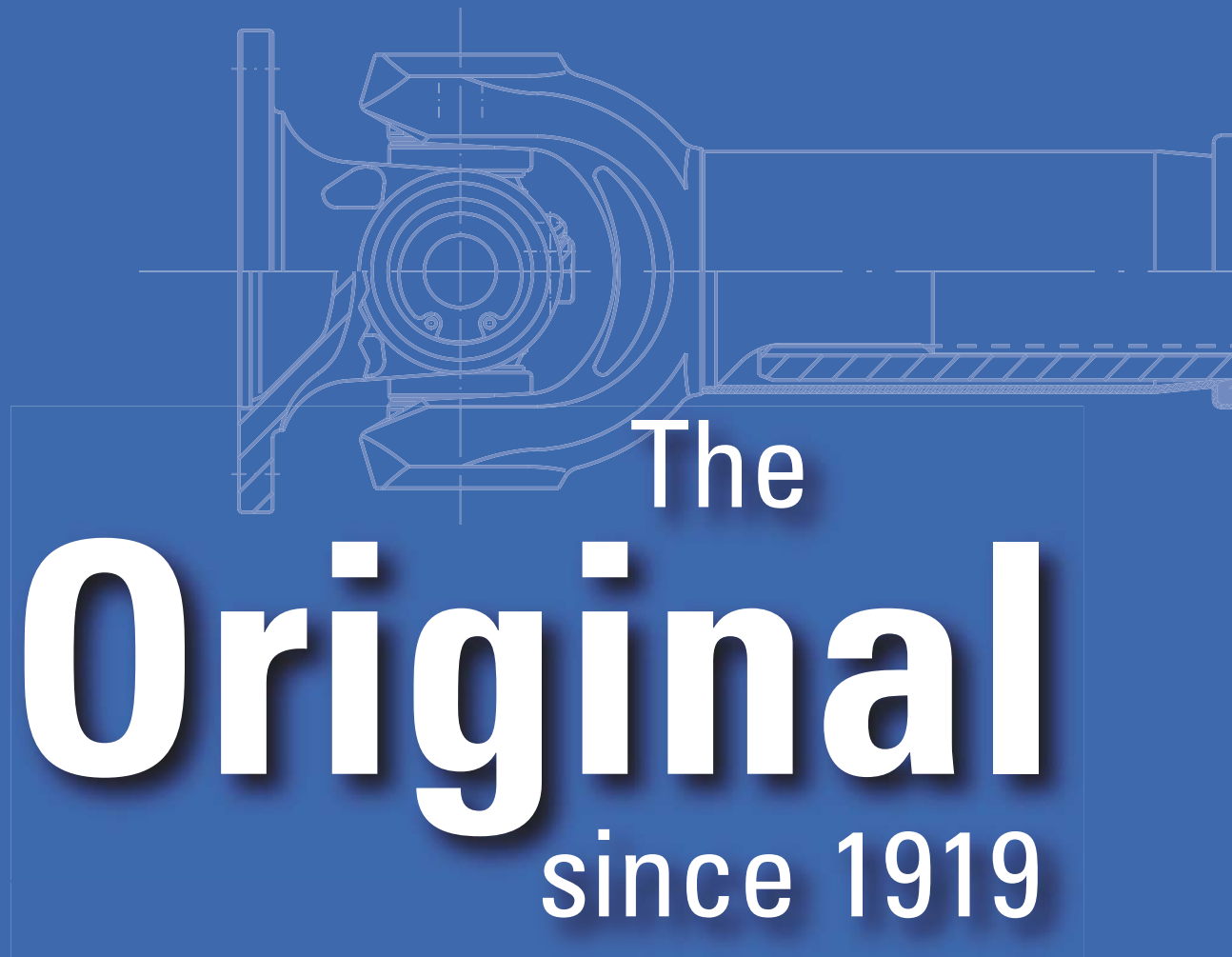

The
Original
since 1919

Needle bearing version

At utilisation of the nominal torque a verification of the flange connection is necessary.

One keyway is not enough to transmit the max. torque. In such case a second keyway or an internal spline is recommended.

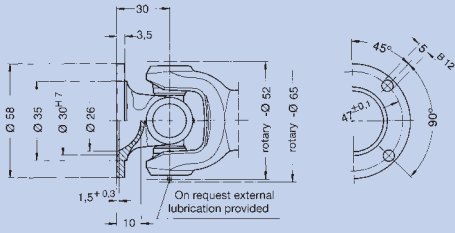

On both sides standard flange end number: 0.105.XX0

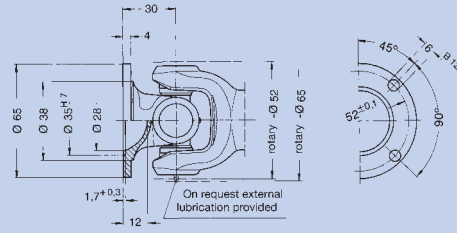

On both sides larger flange end number: 0.105.XX1

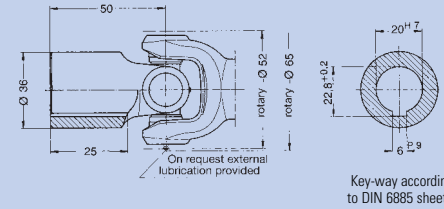

On both sides connecting hub without key-way end number: 0.105.XX2 with key-way end number: 0.105.XX3

- β = Maximum angle of deflection per joint
- J_m = Moment of inertia
- G = Weight
- S_{min} = Minimum length of tubular types
- S₁ = Compressed lengths
- S₂ = of short types
- X₁ = Extension at S_{min} resp. S₁
- X₂ = Extension at S₂
- P₁ = Tube diameter. Dimensions in bold type for normal applications. Alternative dimensions are for long shafts at high speeds, see technical annex domain speed
- P₂ = Alternative tube
- P₃ = Alternative tube

Universal Cardan Drive-Shafts with extension

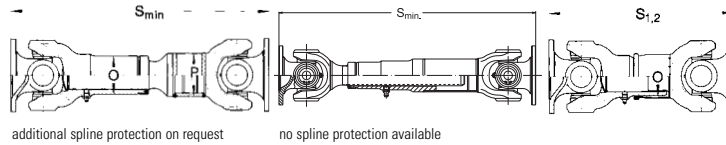

Cardan Drive-Shafts without extension

Universal Joints without extension

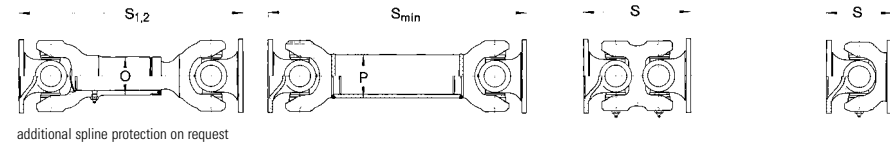

Please indicate requested length „S“ and max. r.p.m. when ordering!

Order number	Tubular Type normal extension				Tubular Type larger extension				Short Type I		
	0.105.100	0.105.101	0.105.102	-	0.105.110	0.105.111	0.105.112	-	0.105.130	0.105.131	0.105.132
Angle of deflection β	30	25	30	-	30	25	30	-	30	25	30
Flange-Ø	58	65	Hub	-	58	65	Hub	-	58	65	Hub
S _{min} resp. S ₁	240	240	280	-	257	257	297	-	165	165	205
S ₂	-	-	-	-	-	-	-	-	175	175	215
X resp. X ₁	25	25	25	-	40	40	40	-	20	20	20
X ₂	-	-	-	-	-	-	-	-	25	25	25
P ₁	28 x 1,5	28 x 1,5	28 x 1,5	-	28 x 1,5	28 x 1,5	28 x 1,5	-	-	-	-
P ₂	40 x 2	40 x 2	40 x 2	-	40 x 2	40 x 2	40 x 2	-	-	-	-
P ₃	-	-	-	-	-	-	-	-	-	-	-
Spline dim. DIN 5480	20x1,5x12	20x1,5x12	20x1,5x12	-	20x1,5x12	20x1,5x12	20x1,5x12	-	20x1,5x12	20x1,5x12	20x1,5x12
Number of flange holes	4	4	-	-	4	4	-	-	4	4	-
J _m (at S _{min} resp. S ₁)	0,000185	0,00022	0,00019	-	0,00019	0,000225	0,000195	-	0,00018	0,00021	0,000185
J _m (at S ₂)	-	-	-	-	-	-	-	-	0,00021	0,00024	0,000215
J _m /100 mm standard tube	0,000017	0,000017	0,000017	-	0,000017	0,000017	0,000017	-	-	-	-
G (at S _{min} resp. S ₁)	1,18	1,25	1,31	-	1,26	1,33	1,39	-	0,93	1,00	1,07
G (at S ₂)	-	-	-	-	-	-	-	-	0,98	1,05	1,12
G/100 mm standard tube	0,1	0,1	0,1	-	0,1	0,1	0,1	-	-	-	-

Short Type II				Tubular Type				Universal Joint Double			Universal Joint Single			
0.105.140	0.105.141	0.105.142	-	0.105.200	0.105.201	0.105.202	-	0.105.300	0.105.301	0.105.302	0.105.400	0.105.401	0.105.402	-
30	25	30	-	30	25	30	-	30	25	30	30	25	30	-
58	65	Hub	-	58	65	Hub	-	58	65	Hub	58	65	Hub	-
195	195	235	-	160	160	200	-	110	110	150	60	60	100	-
215	215	255	-	-	-	-	-	-	-	-	-	-	-	-
25	25	25	-	-	-	-	-	-	-	-	-	-	-	-
25	25	25	-	-	-	-	-	-	-	-	-	-	-	-
-	-	-	-	28 x 1,5	28 x 1,5	28 x 1,5	-	-	-	-	-	-	-	-
-	-	-	-	40 x 2	40 x 2	40 x 2	-	-	-	-	-	-	-	-
-	-	-	-	-	-	-	-	-	-	-	-	-	-	-
20x1,5x12	20x1,5x12	20x1,5x12	-	-	-	-	-	-	-	-	-	-	-	-
4	4	-	-	4	4	-	-	4	4	-	4	4	-	-
0,00022	0,00025	0,00025	-	0,000152	0,000187	0,000157	-	0,00012	0,00015	0,000125	0,000072	0,00011	0,000077	-
0,00024	0,00027	0,000245	-	-	-	-	-	-	-	-	-	-	-	-
-	-	-	-	0,000017	0,000017	0,000017	-	-	-	-	-	-	-	-
0,99	1,06	1,12	-	0,88	0,95	1,01	-	0,69	0,76	0,83	0,40	0,47	0,53	-
1,3	1,10	1,17	-	-	-	-	-	-	-	-	-	-	-	-
-	-	-	-	0,1	0,1	0,1	-	-	-	-	-	-	-	-

Needle bearing version

At utilisation of the nominal torque a verification of the flange connection is necessary.

One keyway is not enough to transmit the max. torque. In such case a second keyway or an internal spline is recommended.

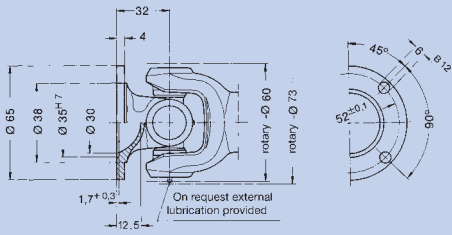

On both sides standard flange
end number: 0.106.XX0

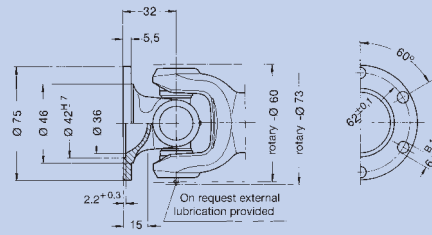

On both sides larger flange
end number: 0.106.XX1

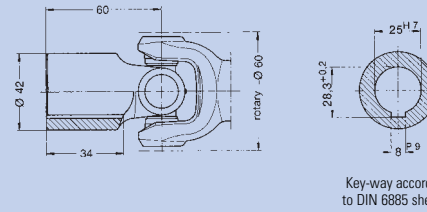

On both sides connecting hub
without key-way end number: 0.106.XX2
with key-way end number: 0.106.XX3

- β = Maximum angle of deflection per joint
- J_m = Moment of inertia
- G = Weight
- S_{min} = Minimum length of tubular types
- S₁ = Compressed lengths
- S₂ = of short types
- X₁ = Extension at S_{min} resp. S₁
- X₂ = Extension at S₂
- P₁ = Tube diameter. Dimensions in bold type for normal applications. Alternative dimensions are for long shafts at high speeds, see technical annex domain speed
- P₂ = Alternative tube
- P₃ = Alternative tube

Universal Cardan Drive-Shafts with extension

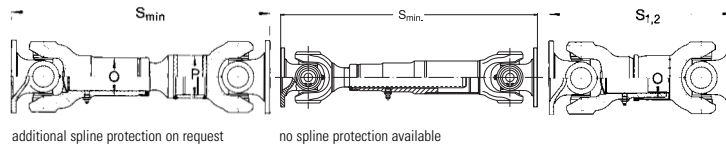

Cardan Drive-Shafts without extension

Universal Joints without extension

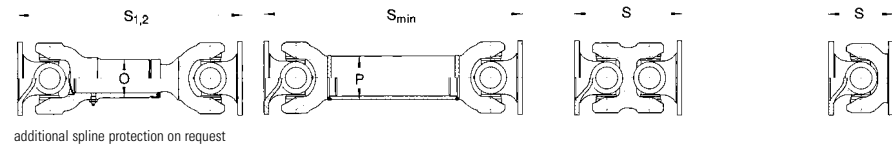

Please indicate requested length „S“ and max. r.p.m. when ordering!

Order number	Tubular Type normal extension				Tubular Type larger extension				Short Type I		
	0.106.100	0.106.101	0.106.102	–	0.106.110	0.106.111	0.106.112	–	0.106.130	0.106.131	0.106.132
Angle of deflection β	30	20	30	–	30	20	30	–	30	20	30
Flange-Ø	65	75	Hub	–	65	75	Hub	–	65	75	Hub
S _{min} resp. S ₁	260	260	315	–	290	290	345	–	180	180	236
S ₂	–	–	–	–	–	–	–	–	200	200	256
X resp. X ₁	30	30	30	–	60	60	60	–	20	20	20
X ₂	–	–	–	–	–	–	–	–	30	30	30
P ₁	32 x 1,5	32 x 1,5	32 x 1,5	–	32 x 1,5	32 x 1,5	32 x 1,5	–	–	–	–
P ₂	50 x 2	50 x 2	50 x 2	–	50 x 2	50 x 2	50 x 2	–	–	–	–
P ₃	70 x 3	70 x 3	70 x 3	–	70 x 3	70 x 3	70 x 3	–	–	–	–
Spline dim. DIN 5480	25x1,5x15	25x1,5x15	25x1,5x15	–	25x1,5x15	25x1,5x15	25x1,5x15	–	25x1,5x15	25x1,5x15	25x1,5x15
Number of flange holes	4	6	–	–	4	6	–	–	4	6	–
J _m (at S _{min} resp. S ₁)	0,000415	0,000587	0,000448	–	0,00044	0,000612	0,00047	–	0,00039	0,00056	0,00042
J _m (at S ₂)	–	–	–	–	–	–	–	–	0,00042	0,00059	0,00045
J _m /100 mm standard tube	0,000026	0,000026	0,000026	–	0,000026	0,000026	0,000026	–	–	–	–
G (at S _{min} resp. S ₁)	1,77	1,95	2,02	–	1,87	2,04	2,11	–	1,39	1,56	1,64
G (at S ₂)	–	–	–	–	–	–	–	–	1,54	1,71	1,78
G/100 mm standard tube	0,11	0,11	0,11	–	0,11	0,11	0,11	–	–	–	–

Short Type II				Tubular Type				Universal Joint Double			Universal Joint Single			
0.106.140	0.106.141	0.106.142	–	0.106.200	0.106.201	0.106.202	–	0.106.300	0.106.301	0.106.302	0.106.400	0.106.401	0.106.402	–
30	20	30	–	30	20	30	–	30	20	30	30	20	30	–
65	75	Hub	–	65	75	Hub	–	65	75	Hub	65	75	Hub	–
220	220	276	–	165	165	220	–	120	120	176	64	64	120	–
235	235	291	–	–	–	–	–	–	–	–	–	–	–	–
30	30	30	–	–	–	–	–	–	–	–	–	–	–	–
30	30	30	–	–	–	–	–	–	–	–	–	–	–	–
–	–	–	–	32 x 1,5	32 x 1,5	32 x 1,5	–	–	–	–	–	–	–	–
–	–	–	–	50 x 2	50 x 2	50 x 2	–	–	–	–	–	–	–	–
–	–	–	–	70 x 3	70 x 3	70 x 3	–	–	–	–	–	–	–	–
25x1,5x15	25x1,5x15	25x1,5x15	–	–	–	–	–	–	–	–	–	–	–	–
4	6	–	–	4	6	–	–	4	6	–	4	6	–	–
0,00043	0,00060	0,00046	–	0,000336	0,00051	0,00036	–	0,00028	0,00045	0,00031	0,00015	0,00032	0,00018	–
0,00045	0,00062	0,00048	–	–	–	–	–	–	–	–	–	–	–	–
–	–	–	–	0,000026	0,000026	0,000026	–	–	–	–	–	–	–	–
1,58	1,75	1,83	–	1,16	1,34	1,41	–	0,99	1,16	1,24	0,56	0,73	0,80	–
1,63	1,80	1,87	–	–	–	–	–	–	–	–	–	–	–	–
–	–	–	–	0,11	0,11	0,11	–	–	–	–	–	–	–	–

Needle bearing version

At utilisation of the nominal torque a verification of the flange connection is necessary.

One keyway is not enough to transmit the max. torque. In such case a second keyway or an internal spline is recommended.

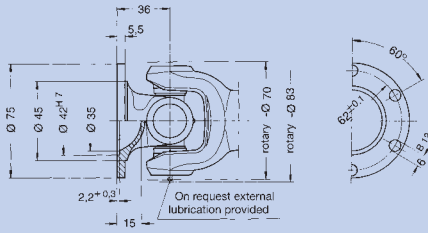

On both sides standard flange
end number: 0.107.XX0

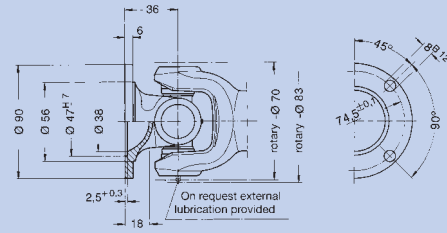

On both sides larger flange
end number: 0.107.XX1

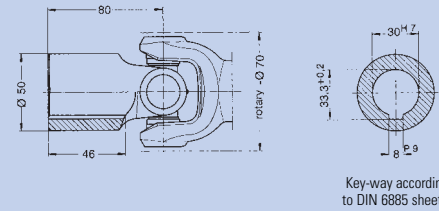

On both sides connecting hub
without key-way end number: 0.107.XX2
with key-way end number: 0.107.XX3

- β = Maximum angle of deflection per joint
- J_m = Moment of inertia
- G = Weight
- S_{min} = Minimum length of tubular types
- S₁ = Compressed lengths
- S₂ = of short types
- X₁ = Extension at S_{min} resp. S₁
- X₂ = Extension at S₂
- P₁ = Tube diameter. Dimensions in bold type for normal applications. Alternative dimensions are for long shafts at high speeds, see technical annex domain speed
- P₂ = Alternative tube
- P₃ = Alternative tube

Universal Cardan Drive-Shafts with extension

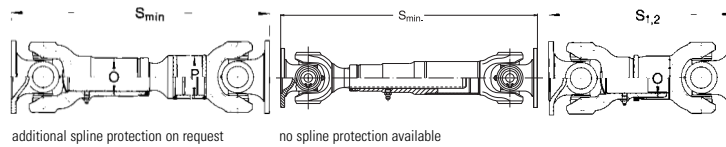

Cardan Drive-Shafts without extension

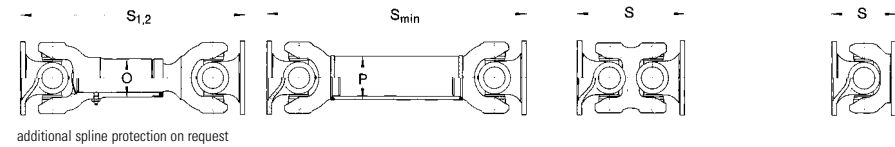

Universal Joints without extension

Please indicate requested length „S“ and max. r.p.m. when ordering!

Order number	Tubular Type normal extension				Tubular Type larger extension				Short Type I			
	0.107.100	0.107.101	0.107.102	—	0.107.110	0.107.111	0.107.112	—	0.107.130	0.107.131	0.107.132	
Angle of deflection β	°	30	18	30	—	30	18	30	—	30	18	30
Flange-Ø	mm	75	90	Hub	—	75	90	Hub	—	75	90	Hub
S _{min} resp. S ₁	mm	300	300	390	—	360	360	450	—	200	200	288
S ₂	mm	—	—	—	—	—	—	—	—	225	225	313
X resp. X ₁	mm	35	35	35	—	70	70	70	—	25	25	25
X ₂	mm	—	—	—	—	—	—	—	—	35	35	35
P ₁	mm	40 x 2	40 x 2	40 x 2	—	40 x 2	40 x 2	40 x 2	—	—	—	—
P ₂	mm	50 x 2	50 x 2	50 x 2	—	50 x 2	50 x 2	50 x 2	—	—	—	—
P ₃	mm	70 x 3	70 x 3	70 x 3	—	70 x 3	70 x 3	70 x 3	—	—	—	—
Spline dim. DIN 5480	mm	28x1,5x17	28x1,5x17	28x1,5x17	—	28x1,5x17	28x1,5x17	28x1,5x17	—	28x1,5x17	28x1,5x17	28x1,5x17
Number of flange holes		6	4	—	—	6	4	—	—	6	4	—
J _m (at S _{min} resp. S ₁)	kgm ²	0,00098	0,00127	0,00121	—	0,00104	0,00133	0,00127	—	0,00089	0,00118	0,00112
J _m (at S ₂)	kgm ²	—	—	—	—	—	—	—	—	0,00092	0,00120	0,00115
J _m /100 mm standard tube	kgm ²	0,000068	0,000068	0,000068	—	0,000068	0,000068	0,000068	—	—	—	—
G (at S _{min} resp. S ₁)	kg	2,60	2,90	3,29	—	3,04	3,35	3,73	—	1,98	2,29	2,67
G (at S ₂)	kg	—	—	—	—	—	—	—	—	2,21	2,51	2,90
G/100 mm standard tube	kg	0,19	0,19	0,19	—	0,19	0,19	0,19	—	—	—	—

Short Type II				Tubular Type				Universal Joint Double			Universal Joint Single			
0.107.140	0.107.141	0.107.142	—	0.107.200	0.107.201	0.107.202	—	0.107.300	0.107.301	0.107.302	0.107.400	0.107.401	0.107.402	—
30	18	30	—	30	18	30	—	30	18	30	30	18	30	—
75	90	Hub	—	75	90	Hub	—	75	90	Hub	75	90	Hub	—
250	250	338	—	200	200	290	—	140	140	228	72	72	160	—
270	270	358	—	—	—	—	—	—	—	—	—	—	—	—
35	35	35	—	—	—	—	—	—	—	—	—	—	—	—
35	35	35	—	—	—	—	—	—	—	—	—	—	—	—
—	—	—	—	40 x 2	40 x 2	40 x 2	—	—	—	—	—	—	—	—
—	—	—	—	50 x 2	50 x 2	50 x 2	—	—	—	—	—	—	—	—
—	—	—	—	70 x 3	70 x 3	70 x 3	—	—	—	—	—	—	—	—
28x1,5x17	28x1,5x17	28x1,5x17	—	—	—	—	—	—	—	—	—	—	—	—
6	4	—	—	6	4	—	—	6	4	—	6	4	—	—
0,00093	0,00121	0,00116	—	0,00078	0,00107	0,00101	—	0,00069	0,00098	0,00092	0,00031	0,00060	0,00054	—
0,00096	0,00124	0,00118	—	—	—	—	—	—	—	—	—	—	—	—
—	—	—	—	0,00068	0,00068	0,00068	—	—	—	—	—	—	—	—
2,27	2,58	2,96	—	1,89	2,20	2,58	—	1,51	1,82	2,21	0,81	1,12	1,50	—
2,36	2,67	3,05	—	—	—	—	—	—	—	—	—	—	—	—
—	—	—	—	0,19	0,19	0,19	—	—	—	—	—	—	—	—

Needle bearing version

At utilisation of the nominal torque a verification of the flange connection is necessary.

One keyway is not enough to transmit the max. torque. In such case a second keyway or an internal spline is recommended.

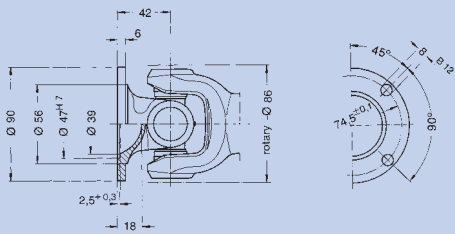

On both sides standard flange
end number: 0.109.XX0

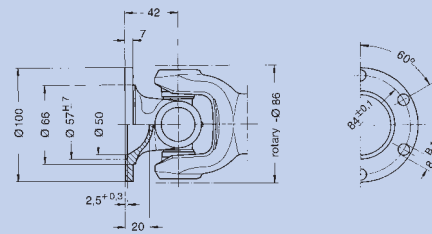

On both sides larger flange
end number: 0.109.XX1

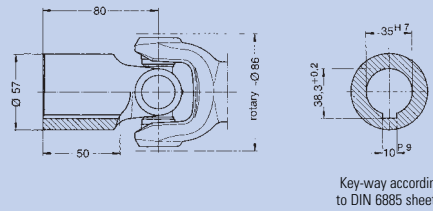

Key-way according to DIN 6885 sheet 1

On both sides connecting hub
without key-way end number: 0.109.XX2
with key-way end number: 0.109.XX3

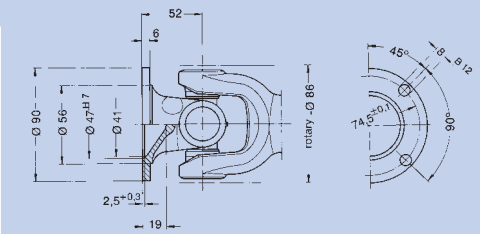

On both sides flange for larger angle deflection
end number: 0.109.XX5

- β = Maximum angle of deflection per joint
- J_m = Moment of inertia
- G = Weight
- S_{min} = Minimum length of tubular types
- S₁ = Compressed lengths
- S₂ = of short types
- X₁ = Extension at S_{min} resp. S₁
- X₂ = Extension at S₂
- P₁ = Tube diameter. Dimensions in bold type for normal applications. Alternative dimensions are for long shafts at high speeds, see technical annex domain speed
- P₂ = Alternative tube
- P₃ = Alternative tube

Universal Cardan Drive-Shafts with extension

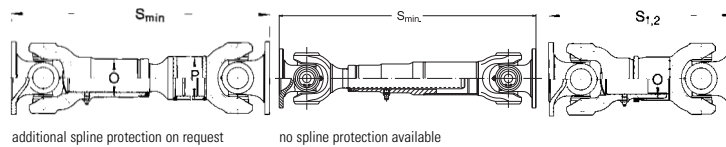

additional spline protection on request

no spline protection available

Cardan Drive-Shafts without extension

Universal Joints without extension

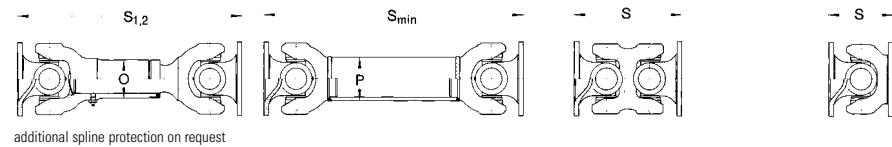

additional spline protection on request

Please indicate requested length „S“ and max. r.p.m. when ordering!

Order number	Tubular Type normal extension				Tubular Type larger extension				Short Type I			
	0.109.100	0.109.101	0.109.102	0.109.105	0.109.110	0.109.111	0.109.112	0.109.115	0.109.130	0.109.131	0.109.132	
Angle of deflection β	°	20	18	20	35	20	18	20	35	20	18	20
Flange-Ø	mm	90	100	Hub	90	90	100	Hub	90	90	100	Hub
S _{min} resp. S ₁	mm	348	348	423	375	393	393	468	425	225	225	301
S ₂	mm	-	-	-	-	-	-	-	-	250	250	326
X resp. X ₁	mm	40	40	40	40	80	80	80	80	25	25	25
X ₂	mm	-	-	-	-	-	-	-	-	40	40	40
P ₁	mm	50 x 2	50 x 2	50 x 2	50 x 2	50 x 2	50 x 2	50 x 2	50 x 2	-	-	-
P ₂	mm	70 x 3	70 x 3	70 x 3	70 x 3	70 x 3	70 x 3	70 x 3	70 x 3	-	-	-
P ₃	mm	80 x 4	80 x 4	80 x 4	80 x 4	80 x 4	80 x 4	80 x 4	80 x 4	-	-	-
Spline dim. DIN 5480	mm	32x2x14	32x2x14	32x2x14	32x2x14	32x2x14	32x2x14	32x2x14	32x2x14	32x2x14	32x2x14	32x2x14
Number of flange holes		4	6	-	4	4	6	-	4	4	6	-
J _m (at S _{min} resp. S ₁)	kgm ²	0,00249	0,00286	0,00267	0,00281	0,00259	0,00296	0,00277	0,00291	0,00221	0,00258	0,00239
J _m (at S ₂)	kgm ²	-	-	-	-	-	-	-	-	0,00226	0,00263	0,00244
J _m /100 mm standard tube	kgm ²	0,00014	0,00014	0,00014	0,00014	0,00014	0,00014	0,00014	0,00014	-	-	-
G (at S _{min} resp. S ₁)	kg	4,91	5,12	5,68	5,10	5,41	5,61	6,18	5,71	3,80	4,00	4,57
G (at S ₂)	kg	-	-	-	-	-	-	-	-	4,11	4,31	4,88
G/100 mm standard tube	kg	0,24	0,24	0,24	0,24	0,24	0,24	0,24	0,24	-	-	-

Short Type II				Tubular Type				Universal Joint Double			Universal Joint Single			
0.109.140	0.109.141	0.109.142	0.109.145	0.109.200	0.109.201	0.109.202	0.109.205	0.109.300	0.109.301	0.109.302	0.109.400	0.109.401	0.109.402	0.109.405
20	18	20	35	20	18	20	35	20	18	20	20	18	20	35
90	100	Hub	90	90	100	Hub	90	90	100	Hub	90	100	Hub	90
280	280	356	315	216	216	291	235	152	152	228	84	84	160	104
310	310	386	345	-	-	-	-	-	-	-	-	-	-	-
40	40	40	40	-	-	-	-	-	-	-	-	-	-	-
40	40	40	40	-	-	-	-	-	-	-	-	-	-	-
-	-	-	-	50 x 2	50 x 2	50 x 2	50 x 2	-	-	-	-	-	-	-
-	-	-	-	70 x 3	70 x 3	70 x 3	70 x 3	-	-	-	-	-	-	-
-	-	-	-	80 x 4	80 x 4	80 x 4	80 x 4	-	-	-	-	-	-	-
32x2x14	32x2x14	32x2x14	32x2x14	-	-	-	-	-	-	-	-	-	-	-
4	6	-	4	4	6	-	4	4	6	-	4	6	-	4
0,00238	0,00275	0,00256	0,00270	0,00239	0,00276	0,00257	0,00239	0,00166	0,00299	0,00184	0,00075	0,0011	0,00093	0,00107
0,00256	0,00293	0,00274	0,00288	-	-	-	-	-	-	-	-	-	-	-
-	-	-	-	0,00014	0,00014	0,00014	0,00014	-	-	-	-	-	-	-
4,22	4,43	5,00	4,58	3,73	3,94	4,50	3,88	3,02	3,23	3,79	1,71	1,92	2,49	1,87
4,38	4,59	5,15	4,66	-	-	-	-	-	-	-	-	-	-	-
-	-	-	-	0,24	0,24	0,24	0,24	-	-	-	-	-	-	-

Roller bearing version

At utilisation of the nominal torque a verification of the flange connection is necessary.

One keyway is not enough to transmit the max. torque. In such case a second keyway or an internal spline is recommended.

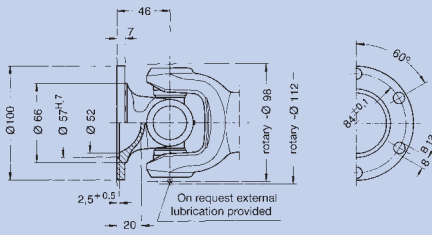

On both sides standard flange
end number: 0.110.XX0

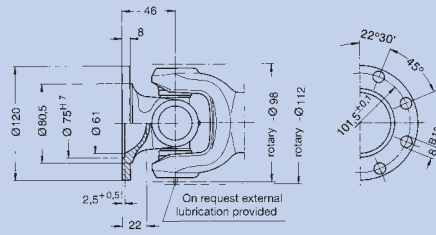

On both sides larger flange
end number: 0.110.XX1

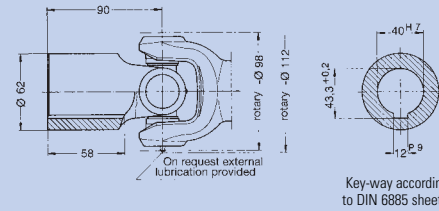

On both sides connecting hub
without key-way end number: 0.110.XX2
with key-way end number: 0.110.XX3

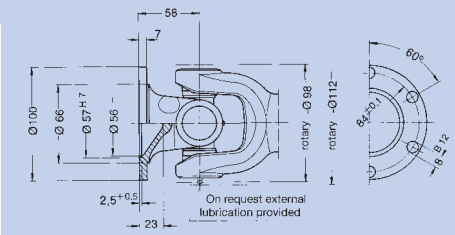

On both sides flange for larger angle deflection
end number: 0.110.XX5

- β = Maximum angle of deflection per joint
- J_m = Moment of inertia
- G = Weight
- S_{min} = Minimum length of tubular types
- S₁ = Compressed lengths
- S₂ = of short types
- X₁ = Extension at S_{min} resp. S₁
- X₂ = Extension at S₂
- P₁ = Tube diameter. Dimensions in bold type for normal applications. Alternative dimensions are for long shafts at high speeds, see technical annex domain speed
- P₂ = Alternative tube
- P₃ = Alternative tube

Universal Cardan Drive-Shafts with extension

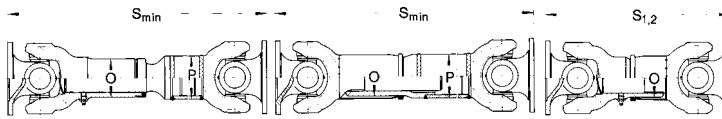

additional spline protection on request

Cardan Drive-Shafts without extension

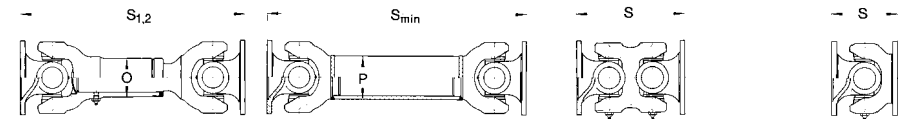

additional spline protection on request

Universal Joints without extension

Please indicate requested length „S“ and max. r.p.m. when ordering!

Order number	Tubular Type normal extension				Tubular Type larger extension				Short Type I		
	0.110.100	0.110.101	0.110.102	0.110.105	0.110.110	0.110.111	0.110.112	0.110.115	0.110.130	0.110.131	0.110.132
Angle of deflection β	20	18	20	35	20	18	20	35	20	18	20
Flange-Ø	100	120	Hub	100	100	120	Hub	100	100	120	Hub
S _{min} resp. S ₁	374	374	464	405	464	464	554	490	255	255	343
S ₂	-	-	-	-	-	-	-	-	280	280	368
X resp. X ₁	40	40	40	40	95	95	95	95	30	30	30
X ₂	-	-	-	-	-	-	-	-	40	40	40
P ₁	50 x 3	50 x 3	50 x 3	50 x 3	50 x 3	50 x 3	50 x 3	50 x 3	-	-	-
P ₂	70 x 3	70 x 3	70 x 3	70 x 3	70 x 3	70 x 3	70 x 3	70 x 3	-	-	-
P ₃	80 x 4	80 x 4	80 x 4	80 x 4	80 x 4	80 x 4	80 x 4	80 x 4	-	-	-
Spline dim. DIN 5480	35x2x16	35x2x16	35x2x16	35x2x16	35x2x16	35x2x16	35x2x16	35x2x16	35x2x16	35x2x16	35x2x16
Number of flange holes	6	8	-	6	6	8	-	6	6	8	-
J _m (at S _{min} resp. S ₁)	0,00378	0,0051	0,0040	0,0041	0,00406	0,00538	0,00428	0,00438	0,00389	0,00521	0,00410
J _m (at S ₂)	-	-	-	-	-	-	-	-	0,00404	0,00536	0,00426
J _m /100 mm standard tube	0,00019	0,00019	0,00019	0,00019	0,00019	0,00019	0,00019	0,00019	-	-	-
G (at S _{min} resp. S ₁)	6,32	6,77	7,08	6,56	7,48	7,93	8,23	7,62	5,12	5,57	5,87
G (at S ₂)	-	-	-	-	-	-	-	-	5,44	5,89	6,19
G/100 mm standard tube	0,35	0,35	0,35	0,35	0,35	0,35	0,35	0,35	-	-	-

Short Type II				Tubular Type				Universal Joint Double			Universal Joint Single			
0.110.140	0.110.141	0.110.142	0.110.145	0.110.200	0.110.201	0.110.202	0.110.205	0.110.300	0.110.301	0.110.302	0.110.400	0.110.401	0.110.402	0.110.405
20	18	20	35	20	18	20	35	18	18	18	20	18	20	35
100	120	Hub	100	100	120	Hub	100	100	120	Hub	100	120	Hub	100
310	310	398	355	250	250	338	270	160	160	248	92	92	180	116
340	340	428	385	-	-	-	-	-	-	-	-	-	-	-
40	40	40	40	-	-	-	-	-	-	-	-	-	-	-
40	40	40	40	-	-	-	-	-	-	-	-	-	-	-
-	-	-	-	50 x 3	50 x 3	50 x 3	50 x 3	-	-	-	-	-	-	-
-	-	-	-	70 x 3	70 x 3	70 x 3	70 x 3	-	-	-	-	-	-	-
-	-	-	-	80 x 4	80 x 4	80 x 4	80 x 4	-	-	-	-	-	-	-
35x2x16	35x2x16	35x2x16	35x2x16	-	-	-	-	-	-	-	-	-	-	-
6	8	-	6	6	8	-	6	6	8	-	6	8	-	6
0,00415	0,00547	0,00437	0,00519	0,00352	0,00484	0,00374	0,00456	0,00319	0,00451	0,00340	0,00152	0,00284	0,00173	0,00204
0,00430	0,00562	0,00452	0,00542	-	-	-	-	-	-	-	-	-	-	-
-	-	-	-	0,00019	0,00019	0,00019	0,00019	-	-	-	-	-	-	-
5,63	6,08	6,38	6,05	4,9	5,35	5,65	5,02	3,98	4,43	4,73	2,25	2,70	3,00	2,39
5,88	6,33	6,63	6,25	-	-	-	-	-	-	-	-	-	-	-
-	-	-	-	0,35	0,35	0,35	0,35	-	-	-	-	-	-	-

Needle or Roller bearing version

At utilisation of the nominal torque a verification of the flange connection is necessary.

One keyway is not enough to transmit the max. torque. In such case a second keyway or an internal spline is recommended.

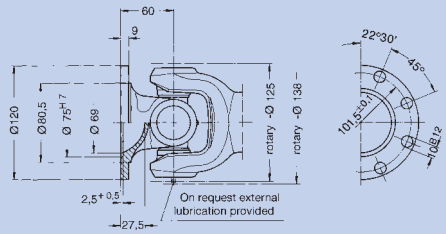

On both sides standard flange
end number: 0.113.XX0

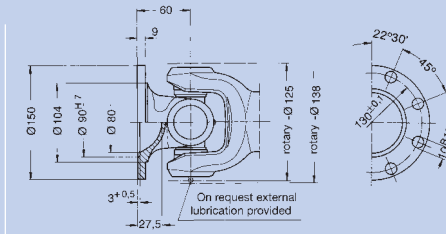

On both sides larger flange
end number: 0.113.XX1

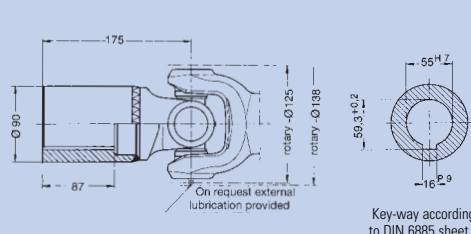

On both sides connecting hub
without key-way end number: 0.113.XX2
with key-way end number: 0.113.XX3

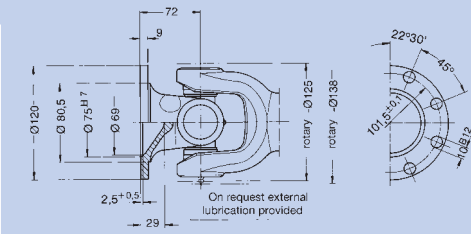

On both sides flange for larger angle deflection
end number: 0.113.XX5

- β = Maximum angle of deflection per joint
- J_m = Moment of inertia
- G = Weight
- S_{min} = Minimum length of tubular types
- S₁ = Compressed lengths
- S₂ = of short types
- X₁ = Extension at S_{min} resp. S₁
- X₂ = Extension at S₂
- P₁ = Tube diameter. Dimensions in bold type for normal applications. Alternative dimensions are for long shafts at high speeds, see technical annex domain speed
- P₂ = Alternative tube
- P₃ = Alternative tube

Universal Cardan Drive-Shafts with extension

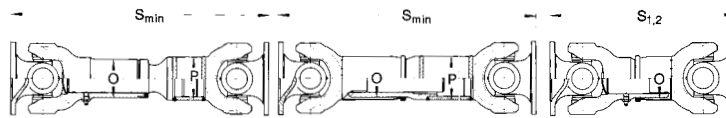

additional spline protection on request

Cardan Drive-Shafts without extension

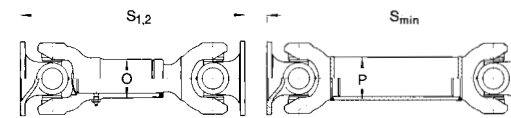

additional spline protection on request

Universal Joints without extension

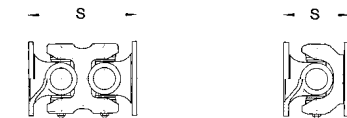

Please indicate requested length „S“ and max. r.p.m. when ordering!

Order number	Tubular Type normal extension				Tubular Type larger extension				Short Type I		
	0.113.100	0.113.101	0.113.102	0.113.105	0.113.110	0.113.111	0.113.112	0.113.115	0.113.130	0.113.131	0.113.132
Angle of deflection β	20	18	20	35	20	18	20	35	20	18	20
Flange-Ø	120	150	Hub	120	120	150	Hub	120	120	150	Hub
S _{min} resp. S ₁	491	491	721	530	556	556	786	580	345	345	575
S ₂	-	-	-	-	-	-	-	-	375	375	605
X resp. X ₁	60	60	60	60	130	130	130	130	35	35	35
X ₂	-	-	-	-	-	-	-	-	50	50	50
P ₁	70 x 4	70 x 4	70 x 4	70 x 4	70 x 4	70 x 4	70 x 4	70 x 4	-	-	-
P ₂	80 x 4	80 x 4	80 x 4	80 x 4	80 x 4	80 x 4	80 x 4	80 x 4	-	-	-
P ₃	100 x 4	100 x 4	100 x 4	100 x 4	100 x 4	100 x 4	100 x 4	100 x 4	-	-	-
Spline dim. DIN 5480	50x2x24	50x2x24	50x2x24	50x2x24	50x2x24	50x2x24	50x2x24	50x2x24	50x2x24	50x2x24	50x2x24
Number of flange holes	8	8	-	8	8	8	-	8	8	8	-
J _m (at S _{min} resp. S ₁)	0,01811	0,0218	0,01897	0,0199	0,02019	0,02388	0,02211	0,02324	0,01773	0,02142	0,02302
J _m (at S ₂)	-	-	-	-	-	-	-	-	0,01807	0,02176	0,02336
J _m /100 mm standard tube	0,00071	0,00071	0,00071	0,00071	0,00071	0,00071	0,00071	0,00071	-	-	-
G (at S _{min} resp. S ₁)	13,66	15,02	19,88	14,55	15,46	16,82	21,75	16,12	11,31	12,67	17,53
G (at S ₂)	-	-	-	-	-	-	-	-	12,03	13,39	18,25
G/100 mm standard tube	0,65	0,65	0,65	0,65	0,65	0,65	0,65	0,65	-	-	-

Short Type II				Tubular Type				Universal Joint Double			Universal Joint Single			
0.113.140	0.113.141	0.113.142	0.113.145	0.113.200	0.113.201	0.113.202	0.113.205	0.113.300	0.113.301	0.113.302	0.113.400	0.113.401	0.113.402	0.113.405
20	18	20	35	20	18	35	35	12	12	12	20	18	35	35
120	150	Hub	120	120	150	Hub	120	120	150	Hub	120	150	Hub	120
420	420	650	460	307	307	534	330	200	200	430	120	120	350	144
450	450	680	495	-	-	-	-	-	-	-	-	-	-	-
60	60	60	60	-	-	-	-	-	-	-	-	-	-	-
60	60	60	60	-	-	-	-	-	-	-	-	-	-	-
-	-	-	-	70 x 4	70 x 4	70 x 4	70 x 4	-	-	-	-	-	-	-
-	-	-	-	80 x 4	80 x 4	80 x 4	80 x 4	-	-	-	-	-	-	-
-	-	-	-	100 x 4	100 x 4	100 x 4	100 x 4	-	-	-	-	-	-	-
50x2x24	50x2x24	50x2x24	50x2x24	-	-	-	-	-	-	-	-	-	-	-
8	8	-	8	8	8	-	8	8	8	-	8	8	-	8
0,01512	0,01881	0,02041	0,01836	0,01436	0,01805	0,0156	0,01591	0,01336	0,01705	0,01465	0,00510	0,00879	0,01039	0,00998
0,01546	0,01915	0,02075	0,01866	-	-	-	-	-	-	-	-	-	-	-
-	-	-	-	0,00071	0,00071	0,00071	0,00071	-	-	-	-	-	-	-
12,60	13,96	18,83	13,47	9,36	10,72	15,56	10,02	7,97	9,33	14,04	4,42	5,78	10,66	5,10
12,94	14,30	19,17	13,92	-	-	-	-	-	-	-	-	-	-	-
-	-	-	-	0,65	0,65	0,65	0,65	-	-	-	-	-	-	-

Roller bearing version

At utilisation of the nominal torque a verification of the flange connection is necessary.

One keyway is not enough to transmit the max. torque. In such case a second keyway or an internal spline is recommended.

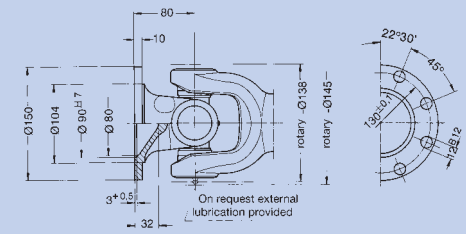
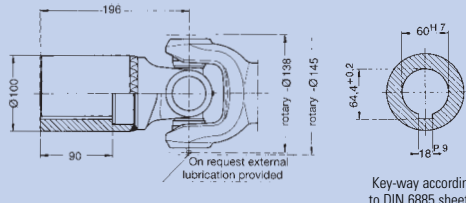
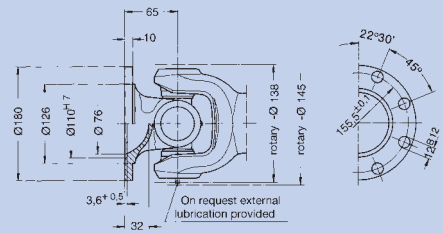
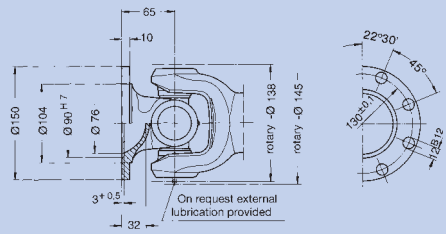

On both sides standard flange
end number: 0.148.XX0

On both sides larger flange
end number: 0.148.XX1

On both sides connecting hub
without key-way end number: 0.148.XX2
with key-way end number: 0.148.XX3

On both sides flange for larger angle deflection
end number: 0.148.XX5

- β = Maximum angle of deflection per joint
- J_m = Moment of inertia
- G = Weight
- S_{min} = Minimum length of tubular types
- S₁ = Compressed lengths
- S₂ = of short types
- X₁ = Extension at S_{min} resp. S₁
- X₂ = Extension at S₂
- P₁ = Tube diameter. Dimensions in bold type for normal applications. Alternative dimensions are for long shafts at high speeds, see technical annex domain speed
- P₂ = Alternative tube
- P₃ = Alternative tube

Universal Cardan Drive-Shafts with extension

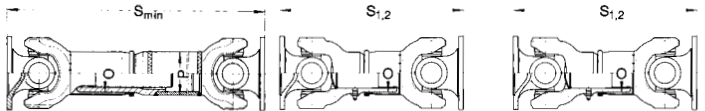

Cardan Drive-Shafts without extension Universal Joints without extension

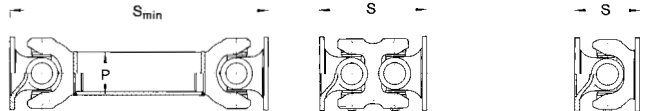

Please indicate requested length „S“ and max. r.p.m. when ordering!

	Tubular Type larger extension				Short Type I			Short Type II			
Order number	0.148.110	0.148.111	0.148.112	0.148.115	0.148.130	0.148.131	0.148.132	0.148.140	0.148.141	0.148.142	0.148.145
Angle of deflection β	20	20	35	35	20	20	20	20	20	20	35
Flange-Ø	150	180	Hub	120/150	150	180	Hub	150	180	Hub	120/150
S _{min} resp. S ₁	550	550	812	580	360	360	622	460	460	722	490
S ₂	-	-	-	-	400	400	662	-	-	-	-
X resp. X ₁	110	110	110	110	40	40	40	80	80	80	80
X ₂	-	-	-	-	80	80	80	-	-	-	-
P ₁	80 x 4	80 x 4	80 x 4	80 x 4	-	-	-	-	-	-	-
P ₂	90 x 4	90 x 4	90 x 4	90 x 4	-	-	-	-	-	-	-
P ₃	100 x 4	100 x 4	100 x 4	100 x 4	-	-	-	-	-	-	-
Spline dim. DIN 5480	55x2,5x20	55x2,5x20	55x2,5x20	55x2,5x20	55x2,5x20	55x2,5x20	55x2,5x20	55x2,5x20	55x2,5x20	55x2,5x20	55x2,5x20
Number of flange holes	8	8	-	8	8	8	-	8	8	-	8
J _m (at S _{min} resp. S ₁)	0,0323	0,0342	0,0406	0,0332	0,0247	0,0267	0,03414	0,0294	0,0314	0,03884	0,0304
J _m (at S ₂)	-	-	-	-	0,0267	0,0287	0,03614	-	-	-	-
J _m /100 mm standard tube	0,00109	0,00109	0,00109	0,00109	-	-	-	-	-	-	-
G (at S _{min} resp. S ₁)	20,87	22,17	29,77	22,19	15,63	16,93	24,53	18,37	19,67	27,27	19,69
G (at S ₂)	-	-	-	-	16,88	16,55	25,77	-	-	-	-
G/100 mm standard tube	0,75	0,75	0,75	0,75	-	-	-	-	-	-	-

Tubular Type				Universal Joint Double			Universal Joint Single			
0.148.200	0.148.201	0.148.202	0.148.205	0.148.300	0.148.301	0.148.302	0.148.400	0.148.401	0.148.402	0.148.405
20	20	35	35	20	20	20	20	20	35	35
150	180	Hub	120/150	150	180	Hub	150	180	Hub	120/150
345	345	607	375	235	235	497	130	130	392	160
-	-	-	-	-	-	-	-	-	-	-
-	-	-	-	-	-	-	-	-	-	-
80 x 4	80 x 4	80 x 4	80 x 4	-	-	-	-	-	-	-
90 x 4	90 x 4	90 x 4	90 x 4	-	-	-	-	-	-	-
100 x 4	100 x 4	100 x 4	100 x 4	-	-	-	-	-	-	-
-	-	-	-	-	-	-	-	-	-	-
8	8	-	8	8	8	-	8	8	-	8
0,0217	0,0237	0,03144	0,0227	0,0149	0,0161	0,0162	0,0106	0,0126	0,02004	0,0117
0,00109	0,00109	0,00109	0,00109	-	-	-	-	-	-	-
14,53	15,83	23,43	15,85	11,92	13,22	20,82	6,75	8,05	15,54	8,08
-	-	-	-	-	-	-	-	-	-	-
0,75	0,75	0,75	0,75	-	-	-	-	-	-	-

Roller bearing version

At utilisation of the nominal torque a verification of the flange connection is necessary.

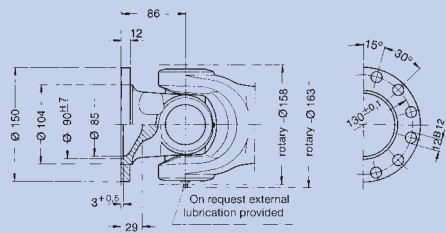

On both sides standard flange
end number: 0.117.XX0

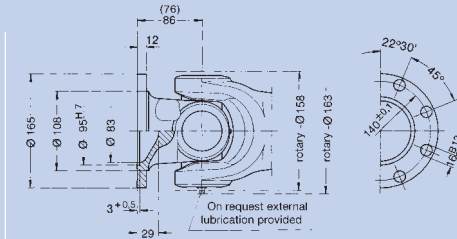

On both sides larger flange (Ø 165 mm)
end number: 0.117.XX1
Dimensions in brackets are only valid for short type I

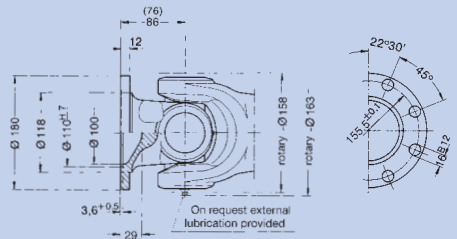

On both sides larger flange (Ø 180 mm)
end number: 0.117.XX1
Dimensions in brackets are only valid for short type I

- β = Maximum angle of deflection per joint
- J_m = Moment of inertia
- G = Weight
- S_{min} = Minimum length of tubular types
- S₁ = Compressed lengths
- S₂ = of short types
- X₁ = Extension at S_{min} resp. S₁
- X₂ = Extension at S₂
- P₁ = Tube diameter. Dimensions in bold type for normal applications. Alternative dimensions are for long shafts at high speeds, see technical annex domain speed
- P₂ = Alternative tube
- P₃ = Alternative tube

Universal Cardan Drive-Shafts with extension

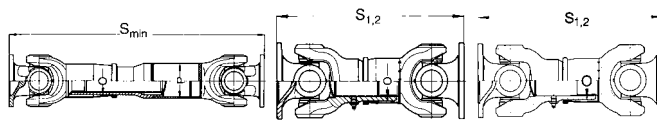

Cardan Drive-Shafts without extension

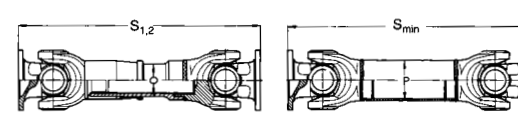

Universal Joints without extension

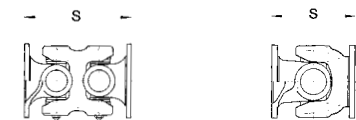

Please indicate requested length „S“ and max. r.p.m. when ordering!

Order number	Tubular Type larger extension			Short Type I		Short Type II		
	0.117.110	0.117.111	0.117.111	0.117.121	0.117.121	0.117.130	0.117.131	0.117.131
Angle of deflection β	30	30	30	24	24	30	30	30
Flange-Ø	150	165	180	165	180	150	165	180
S _{min} resp. S ₁	660	660	660	400	400	495	495	495
S ₂	-	-	-	440	440	555	555	555
X resp. X ₁	110	110	110	40	40	45	45	45
X ₂	-	-	-	50	50	80	80	80
P ₁	100 x 5	100 x 5	100 x 5	-	-	-	-	-
P ₂	120 x 5	120 x 5	120 x 5	-	-	-	-	-
P ₃	-	-	-	-	-	-	-	-
Spline dim. DIN 5480	65x2,5x24	65x2,5x24	65x2,5x24	65x2,5x24	65x2,5x24	65x2,5x24	65x2,5x24	65x2,5x24
Number of flange holes	12	8	8	8	8	12	8	8
J _m (at S _{min} resp. S ₁)	0,04834	0,05185	0,05463	0,0467	0,0491	0,04286	0,04678	0,04917
J _m (at S ₂)	-	-	-	0,04898	0,05139	0,04439	0,04899	0,05139
J _m /100 mm standard tube	0,00265	0,00265	0,00265	-	-	-	-	-
G (at S _{min} resp. S ₁)	35,03	35,51	36,56	25,61	26,52	28,21	28,69	29,74
G (at S ₂)	-	-	-	27,29	28,20	30,88	31,36	32,41
G/100 mm standard tube	1,17	1,17	1,17	-	-	-	-	-

Short Type III			Tubular Type			Universal Joint Double			Universal Joint Single		
0.117.140	0.117.141	0.117.141	0.117.200	0.117.201	0.117.201	0.117.300	0.117.301	0.117.301	0.117.400	0.117.401	0.117.401
30	30	30	30	30	30	15	15	15	30	30	30
150	165	180	150	165	180	150	165	180	150	165	180
600	600	600	430	430	430	296	296	296	172	172	172
110	110	110	-	-	-	-	-	-	-	-	-
-	-	-	-	-	-	-	-	-	-	-	-
-	-	-	100 x 5	100 x 5	100 x 5	-	-	-	-	-	-
-	-	-	120 x 5	120 x 5	120 x 5	-	-	-	-	-	-
-	-	-	-	-	-	-	-	-	-	-	-
-	-	-	-	-	-	-	-	-	-	-	-
12	8	8	12	8	8	12	8	8	12	8	8
0,04665	0,05125	0,05365	0,04054	0,04424	0,04796	0,037	0,0423	0,0468	0,01879	0,02133	0,02568
-	-	-	-	-	-	-	-	-	-	-	-
-	-	-	0,00265	0,00265	0,00265	-	-	-	-	-	-
33,45	33,93	34,98	25,31	25,79	26,84	21,02	21,50	22,57	10,99	11,47	12,52
-	-	-	-	-	-	-	-	-	-	-	-
-	-	-	1,17	1,17	1,17	-	-	-	-	-	-

Roller bearing version

At utilisation of the nominal torque a verification of the flange connection is necessary.

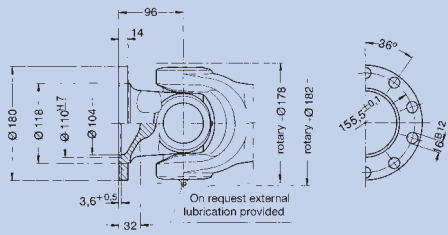

On both sides standard flange
end number: 0.120.XX0

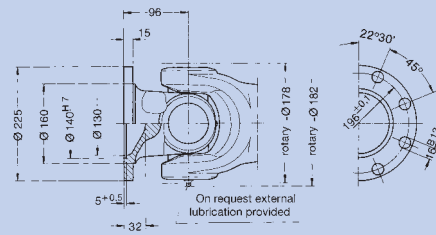

On both sides larger flange
end number: 0.120.XX1

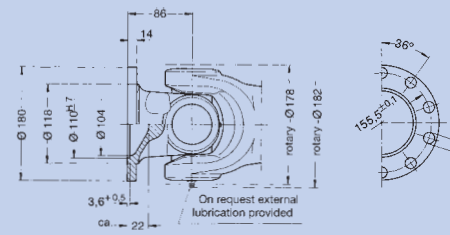

Shorter flange to short type I

β = Maximum angle of deflection per joint
J_m = Moment of inertia
G = Weight
S_{min} = Minimum length of tubular types
S₁ = Compressed lengths
S₂ = of short types
X₁ = Extension at S_{min} resp. S₁
X₂ = Extension at S₂
P₁ = Tube diameter. Dimensions in bold type for normal applications. Alternative dimensions are for long shafts at high speeds, see technical annex domain speed
P₂ = Alternative tube
P₃ = Alternative tube

Universal Cardan Drive-Shafts with extension

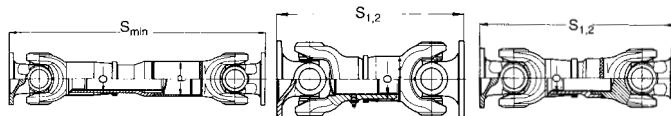

Cardan Drive-Shafts without extension

Universal Joints without extension

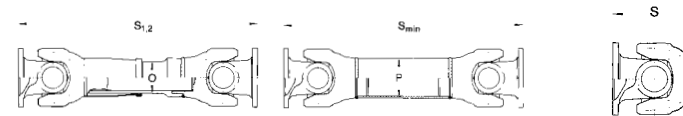

Please indicate requested length „S“ and max. r.p.m. when ordering!

	Tubular Type larger extension		Short Type I	Short Type II	
Order number	0.120.110	0.120.111	0.120.120	0.120.130	0.120.131
Angle of deflection β	30	30	16	30	30
Flange-Ø	180	225	180	180	225
S _{min} resp. S ₁	740	740	470	560	560
S ₂	-	-	500	600	600
X resp. X ₁	110	110	55	45	45
X ₂	-	-	60	60	60
P ₁	110 x 6	110 x 6	-	-	-
P ₂	120 x 6	120 x 6	-	-	-
P ₃	-	-	-	-	-
Spline dim. DIN 5480	75x2,5x28	75x2,5x28	75x2,5x28	75x2,5x28	75x2,5x28
Number of flange holes	10	8	10	10	8
J _m (at S _{min} resp. S ₁)	0,10213	0,14413	0,07320	0,07839	0,12039
J _m (at S ₂)	-	-	0,07493	0,08070	0,12270
J _m /100 mm standard tube	0,004175	0,004175	-	-	-
G (at S _{min} resp. S ₁)	48,75	52,89	36,26	40,27	44,41
G (at S ₂)	-	-	37,76	42,42	46,56
G/100 mm standard tube	1,54	1,54	-	-	-

Short Type III		Tubular Type		Universal Joint Single	
0.120.140	0.120.141	0.120.200	0.120.201	0.120.400	0.120.401
30	30	30	30	30	30
180	225	180	225	180	225
650	650	465	465	192	192
-	-	-	-	-	-
110	110	-	-	-	-
-	-	-	-	-	-
-	-	110 x 6	110 x 6	-	-
-	-	120 x 6	120 x 6	-	-
-	-	-	-	-	-
75x2,5x28	75x2,5x28	-	-	-	-
10	8	10	8	10	8
0,08228	0,12428	0,07247	0,11447	0,03696	0,07896
-	-	-	-	-	-
-	-	0,004175	0,004175	-	-
45,10	49,24	33,90	38,05	14,10	18,88
-	-	-	-	-	-
-	-	1,54	1,54	-	-

Roller bearing version

At utilisation of the nominal torque a verification of the flange connection is necessary.

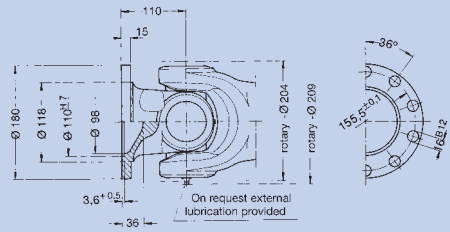

On both sides standard flange end number: 0.122.XX0

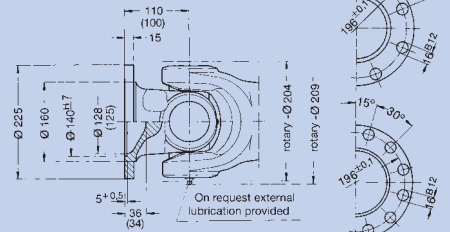

On both sides larger flange (Ø 225 mm) end number: 0.122.XX1
Dimensions in brackets are only valid for short type I

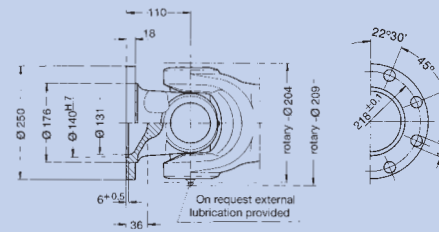

On both sides larger flange (Ø 250 mm) end number: 0.122.XX1

- β = Maximum angle of deflection per joint
- J_m = Moment of inertia
- G = Weight
- S_{min} = Minimum length of tubular types
- S₁ = Compressed lengths
- S₂ = of short types
- X₁ = Extension at S_{min} resp. S₁
- X₂ = Extension at S₂
- P₁ = Tube diameter. Dimensions in bold type for normal applications. Alternative dimensions are for long shafts at high speeds, see technical annex domain speed
- P₂ = Alternative tube
- P₃ = Alternative tube

Universal Cardan Drive-Shafts with extension

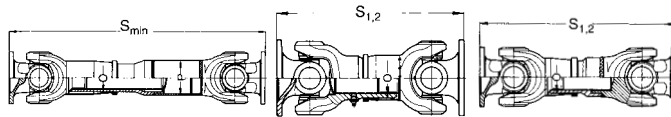

Cardan Drive-Shafts without extension

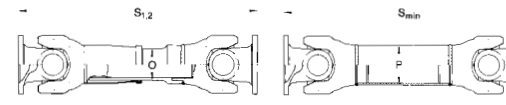

Universal Joints without extension

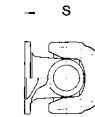

Please indicate requested length „S“ and max. r.p.m. when ordering!

	Tubular Type larger extension				Short Type I	Short Type II			
Order number	0.122.110	0.122.111	0.122.111	0.122.111	0.122.121	0.122.130	0.122.131	0.122.131	0.122.131
Angle of deflection β	30	30	30	25	25	30	30	30	25
Flange-Ø	180	225	225	250	225	180	225	225	250
S _{min} resp. S ₁	830	830	830	830	550	650	650	650	650
S ₂	-	-	-	-	600	-	-	-	-
X resp. X ₁	140	140	140	140	40	80	80	80	80
X ₂	-	-	-	-	55	-	-	-	-
P ₁	120 x 6	120 x 6	124 x 8	124 x 8	-	-	-	-	-
P ₂	140 x 6,5	140 x 6,5	140 x 6,5	140 x 6,5	-	-	-	-	-
P ₃	-	-	-	-	-	-	-	-	-
Spline dim. DIN 5480	90x2,5x34	90x2,5x34	90x2,5x34	90x2,5x34	90x2,5x34	90x2,5x34	90x2,5x34	90x2,5x34	90x2,5x34
Number of flange holes	10	8	12	8	8	10	8	12	8
J _m (at S _{min} resp. S ₁)	0,1558	0,1781	0,1792	0,1884	0,1453	0,1202	0,1565	0,1565	0,1853
J _m (at S ₂)	-	-	-	-	0,1509	-	-	-	-
J _m /100 mm standard tube	0,00550	0,00550	0,00774	0,00774	-	-	-	-	-
G (at S _{min} resp. S ₁)	72,05	76,93	77,49	80,82	61,04	60,67	65,55	65,55	68,79
G (at S ₂)	-	-	-	-	64,85	-	-	-	-
G/100 mm standard tube	1,69	1,69	2,29	2,29	-	-	-	-	-

Short Type III				Tubular Type				Universal Joint Single			
0.122.140	0.122.141	0.122.141	0.122.141	0.122.200	0.122.201	0.122.201	0.122.201	0.122.400	0.122.401	0.122.401	0.122.401
30	30	30	25	30	30	30	25	30	30	30	25
180	225	225	250	180	225	225	250	180	225	225	250
720	720	720	720	520	520	520	520	220	220	220	220
110	110	110	110	-	-	-	-	-	-	-	-
-	-	-	-	120 x 6	120 x 6	124 x 8	124 x 8	-	-	-	-
-	-	-	-	140 x 6,5	140 x 6,5	140 x 6,5	140 x 6,5	-	-	-	-
-	-	-	-	-	-	-	-	-	-	-	-
90x2,5x34	90x2,5x34	90x2,5x34	90x2,5x34	-	-	-	-	-	-	-	-
10	8	12	8	10	8	12	8	10	8	12	8
0,1272	0,1636	0,1636	0,1840	0,1195	0,1642	0,1645	0,1846	0,05597	0,0923	0,0923	0,1211
-	-	-	-	0,00550	0,00550	0,00774	0,00774	-	-	-	-
66,07	70,95	70,95	74,19	45,70	50,58	50,91	54,24	20,77	25,64	25,64	28,86
-	-	-	-	-	-	-	-	-	-	-	-
-	-	-	-	1,69	1,69	2,29	2,29	-	-	-	-

At utilisation of the nominal torque a verification of the flange connection is necessary.

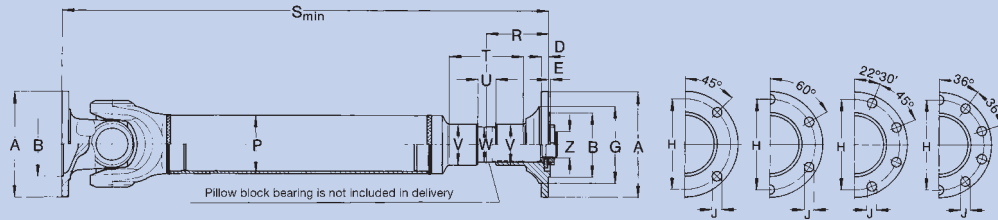

For missing dimensions and details see according series.

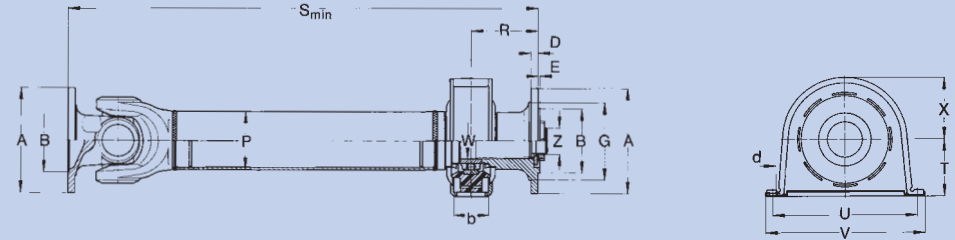

For missing dimensions and details see according series.
Flange illustrations see intermediate shafts without pillow block bearings.

Please indicate requested length „S“ and max. r.p.m. when ordering!

Universal-Joint Intermediate Shaft for SKF-pillow block bearing (are not included in delivery)

Order number	0.109.250	0.110.250	0.112.250	0.113.250	0.148.250	0.158.250	0.117.251	0.120.250	0.122.250	0.122.251
Md _{Nom} Nm	1700	2300	3350	4100	5500	8200	10000	16850	26750	26750
Angle of deflection β °	20	20	20	20	20	35	30	30	30	30
For pillow block bearing	SNH 207	SNH 207	SNH 209	SNH 209	SNH 211	SNH 211	SNH 213	SNH 215	SNH 216	SNH 216
A mm	90	100	120	120	150	150	180	180	180	225
B _{H6} ^{H7} mm	47	57	75	75	90	90	110	110	110	140
D mm	8	8	9	9	10	10	12	14	14	15
E _{0.2} mm	2,3	2,3	2,3	2,3	2,8	2,8	2,8	2,8	2,8	4,5
G _{0.3} mm	61,1	70,6	88,1	84,1	110,6	110,6	131	131	131	171,5
H ^{+0.1} mm	74,5	84	101,5	101,5	130	130	155,5	155,5	155,5	196
J ^{B12} mm	8	8	8	10	12	12	16	16	16	16
P ₁ mm	50 x 2	50 x 3	60 x 4	70 x 4	80 x 4	90 x 4	100 x 5	110 x 6	120 x 6	124 x 8
P ₂ mm	70 x 3	70 x 3	80 x 4	80 x 4	90 x 4	100 x 4	120 x 5	120 x 6	124 x 8	140 x 6,5
P ₃ mm	80 x 4	80 x 4	90 x 4	100 x 4	100 x 4	120 x 5	–	–	–	–
R mm	68,5	68,5	71,5	71,5	87,5	87,5	105,5	115,5	135,5	135,5
S _{min} mm	253	269	305	308	360	420	446	480	540	540
T mm	100	100	100	100	112	112	125	142	147	147
U mm	23	23	23	23	25	25	31	31	33	33
V ₁₀ mm	45	45	55	55	65	65	75	85	90	90
W mm	35	35	45	45	55	55	65	75	80	80
Z mm	M16 x 1,5	M16 x 1,5	M20 x 1,5	M20 x 1,5	M32 x 1,5	M32 x 1,5	M45 x 1,5	M45 x 1,5	M45 x 1,5	M45 x 1,5
Weight kg	3,95	4,68	7,60	8,59	14,25	17,90	25,64	32,06	–	47,44
Tooth/spline dim. mm	35 x 31	35 x 31	45 x 41	45 x 41	55 x 50	55 x 50	62x54x20	70x61x20	75x66x22	75x66x22
Number of flange holes	4	6	8	8	8	8	8	10	10	8
J _m (at S _{min}) kgm ²	0,000531	0,00324	0,008786	0,01198	0,02496	0,04510	0,04564	0,1089	–	–
J _m /100 mm standard tube kgm ²	0,00014	0,00019	0,00044	0,00071	0,00109	0,00157	0,00265	0,00418	–	–
G (at S _{min}) kg	4,0	4,7	7,5	9,0	13,3	18,5	25,9	31,7	46,0	47,5
G/100 mm standard tube kg	0,24	0,35	0,55	0,65	0,75	0,85	1,17	1,54	1,69	2,29

Please indicate requested length „S“ and max. r.p.m. when ordering!

Universal-Joint Intermediate Shaft cpl. with elastic pillow block bearing

Order number	0.109.260	0.110.260	0.112.260	0.113.260	0.148.260	0.158.260	0.117.261	0.120.260
Md _{Nom} Nm	1700	2300	3350	4100	5500	8200	10000	16850
Angle of deflection β °	20	20	20	20	20	35	30	30
For pillow block bearing	1000958350	1000958350	1000958450	1000958450	1000958500	1000958550	1000958600	1000958700
A mm	90	100	120	120	150	150	180	180
B _{H6} ^{H7} mm	47	57	75	75	90	90	110	110
d mm	45	45	58	58	58	60	60	63,5
D mm	8	8	9	9	10	12	12	14
d mm	12,8	12,8	13	13	14,2	15	15	16
E _{0.2} mm	2,3	2,3	2,3	2,3	2,3	2,8	2,8	2,8
G _{0.3} mm	61,1	70,6	88,1	84,1	110,6	110,6	133	131
H ^{+0.1} mm	74,5	84	101,5	101,5	130	130	155,5	155,5
J ^{B12} mm	8	8	8	10	12	12	16	16
P ₁ mm	50 x 2	50 x 3	60 x 4	70 x 4	80 x 4	90 x 4	100 x 5	110 x 6
P ₂ mm	70 x 3	70 x 3	80 x 4	80 x 4	90 x 4	100 x 4	120 x 5	120 x 6
P ₃ mm	80 x 4	80 x 4	90 x 4	100 x 4	100 x 4	120 x 5	–	–
R mm	68,3	68,3	71,3	71,5	87,5	95	100	107
S _{min} mm	238	254	293	296	339	410	405	425
T mm	58,8	58,8	70	70	70	71,5	80	85,5
U mm	168	168	193,6	193,6	193,6	193,6	200	219,2
V mm	198	198	228	228	228	230	243	260
W mm	35	35	45	45	50	55	60	70
X mm	73	69	–	–	–	–	–	–
Z mm	M16 x 1,5	M16 x 1,5	M20 x 1,5	M20 x 1,5	M32 x 1,5	M32 x 1,5	M45 x 1,5	M45 x 1,5
Tooth/spline dim. mm	35 x 31	35 x 31	45 x 41	45 x 41	50 x 45	55 x 50	60x2,5x22	70x2,5x26
Number of flange holes	4	6	8	8	8	8	8	10
J _m (at S _{min}) kgm ²	0,000514	0,00322	0,008748	0,01194	0,02485	0,04503	0,04523	0,10788
J _m /100 mm standard tube kgm ²	0,00014	0,00019	0,00044	0,00071	0,00109	0,00157	0,00265	0,00418
G (at S _{min}) kg	5,40	6,18	9,99	10,69	16,12	20,05	28,40	34,06
G/100 mm standard tube kg	0,24	0,35	0,55	0,65	0,75	0,85	1,17	1,54

β = Maximum angle of deflection per joint
J_m = Moment of inertia
G = Weight
S_{min} = Minimum length of tubular types

P₁ = Tube diameter. Dimensions in bold type for normal applications.
Alternative dimensions are for long shafts at high speeds, see technical annex domain speed

P₂ = Alternative tube
P₃

for SAE-flange-connection, with extension

At utilisation of the nominal torque a verification of the flange connection is necessary.

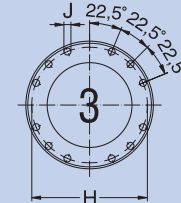
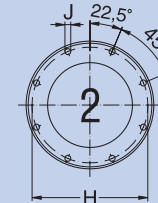
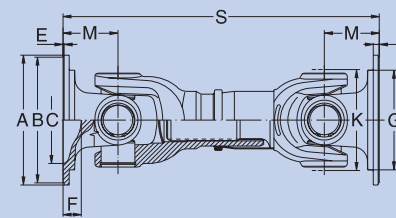
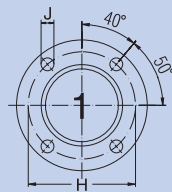
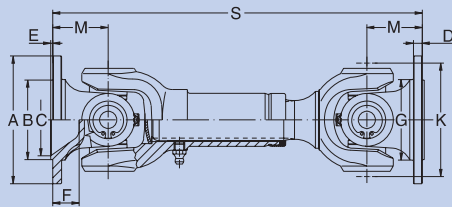

For missing dimensions and details see according series.

For missing dimensions and details see according series.

Please indicate compressed length „S“ and max. r.p.m. when ordering!

		Cardan-Drive-Shafts for SAE-flange-connection, with extension; Size 0.107						Size 0.109		Size 0.110									
Order number		0.107.138.001	0.107.138.002	0.107.148.001	0.107.148.002	0.107.108.001	0.107.118.001	0.109.138.201	0.109.138.202	0.109.148.201	0.109.148.202	0.109.108.201	0.109.118.201	0.110.138.001	0.110.138.002	0.110.148.001	0.110.148.002	0.110.108.001	0.110.118.001
SAE-flange-connection		1100	1100	1100	1100	1100	1100	1310	1310	1310	1310	1310	1310	1350/1410	1350/1410	1350/1410	1350/1410	1350/1410	1350/1410
Elbe joint size		0.107	0.107	0.107	0.107	0.107	0.107	0.109	0.109	0.109	0.109	0.109	0.109	0.110	0.110	0.110	0.110	0.110	0.110
Md _{Nom}	Nm	920	920	920	920	920	920	1700	1700	1700	1700	1700	1700	2300	2300	2300	2300	2300	2300
Angle of deflection β	°	18	18	18	18	18	18	18	18	18	18	18	18	18	18	18	18	18	18
A	mm	87,3	87,3	87,3	87,3	87,3	87,3	96,8	96,8	96,8	96,8	96,8	96,8	116	116	116	116	116	116
B _{-0,04}	mm	57,15	57,15	57,15	57,15	57,15	57,15	60,32	60,32	60,32	60,32	60,32	60,32	69,85	69,85	69,85	69,85	69,85	69,85
C	mm	44	44	44	44	44	44	54	54	54	54	54	54	55	55	55	55	55	55
D	mm	5,2	5,2	5,2	5,2	5,2	5,2	6,7	6,7	6,7	6,7	6,7	6,7	7,5	7,5	7,5	7,5	7,5	7,5
E	mm	1,5 _{-0,1}	1,5 _{-0,1}	1,5 _{-0,1}	1,5 _{-0,1}	1,5 _{-0,1}	1,5 _{-0,1}	1,5 _{-0,1}	1,5 _{-0,1}	1,5 _{-0,1}	1,5 _{-0,1}	1,5 _{-0,1}	1,5 _{-0,1}	1,5 _{-0,1}	1,5 _{-0,1}	1,5 _{-0,1}	1,5 _{-0,1}	1,5 _{-0,1}	1,5 _{-0,1}
F	mm	18	18	18	18	18	18	21,5	21,5	21,5	21,5	21,5	21,5	20	20	20	20	20	20
G	mm	54	54	54	54	54	54	61	61	61	61	61	61	68	68	68	68	68	68
H _{+0,1}	mm	69,85	69,85	69,85	69,85	69,85	69,85	79,4	79,4	79,4	79,4	79,4	79,4	95,25	95,25	95,25	95,25	95,25	95,25
J ^{B12}	mm	7,9	7,9	7,9	7,9	7,9	7,9	9,5	9,5	9,5	9,5	9,5	9,5	11,2	11,2	11,2	11,2	11,2	11,2
K	mm	70	70	70	70	70	70	86	86	86	86	86	86	98	98	98	98	98	98
M	mm	36	36	36	36	36	36	42	42	42	42	42	42	46	46	46	46	46	46
S _{min}	mm	200	225	250	270	300	360	225	250	348	393	393	393	255	280	310	340	374	464
X (extension)	mm	25	35	35	35	35	70	25	40	40	80	80	80	30	40	40	40	40	100
Tooth/spline dim.	mm	28x1,5x17	28x1,5x17	28x1,5x17	28x1,5x17	28x1,5x17	28x1,5x17	32x2x14	32x2x14	32x2x14	32x2x14	32x2x14	32x2x14	35x2x16	35x2x16	35x2x16	35x2x16	35x2x16	35x2x16
Type of flange		1	1	1	1	1	1	1	1	1	1	1	1	1	1	1	1	1	1

β = Maximum angle of deflection per joint
S = Compressed lengths; corresponds to the length of standard type

for SAE-flange-connection, with extension

At utilisation of the nominal torque a verification of the flange connection is necessary.

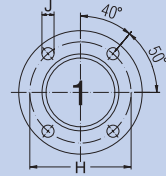
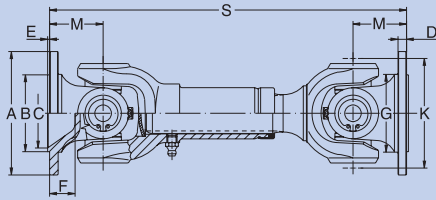

For missing dimensions and details see according series.

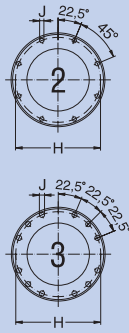
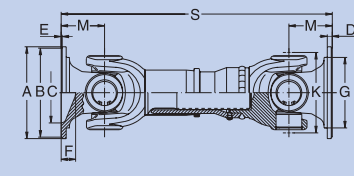
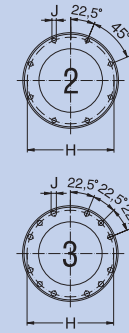
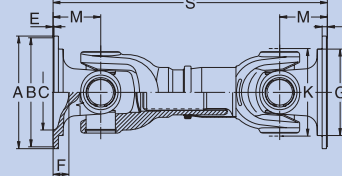

For missing dimensions and details see according series.

Please indicate compressed length „S“ and max. r.p.m. when ordering!

		Cardan-Drive-Shafts for SAE-flange-connection, with extension; Size 0.112						Size 0.148		Size 0.120				Size 0.122				
Order number		0.112.138.201	0.112.138.202	0.112.148.201	0.112.148.202	0.112.108.201	0.112.118.201	0.148.138.001	0.148.138.002	0.148.148.001	0.148.118.001	0.120.138.001	0.120.138.002	0.120.148.001	0.120.118.001	0.122.138.001	0.122.148.001	0.122.118.001
SAE-flange-connection		1510	1510	1510	1510	1510	1510	1600	1600	1600	1600	1800	1800	1800	1800	1900	1900	1900
Elbe joint size		0.112	0.112	0.112	0.112	0.112	0.112	0.148	0.148	0.120	0.120	0.120	0.120	0.120	0.122	0.122	0.122	0.122
Md _{Nom}	Nm	3350	3350	3350	3350	3350	3350	5500	5500	5500	5500	16850	16850	16850	16850	26750	26750	26750
Angle of deflection β	°	18	18	18	18	18	18	18	18	18	18	30	30	30	30	30	30	30
A	mm	146	146	146	146	146	146	174,6	174,6	174,6	174,6	203,2	203,2	203,2	203,2	276,2	276,2	276,2
B _{-0,04}	mm	95,25	95,25	95,25	95,25	95,25	95,25	168,22	168,22	168,22	168,22	196,82	196,82	196,82	196,82	222,2	222,2	222,2
C	mm	82	82	82	82	82	82	98	98	98	98	135	135	135	135	137,5	137,5	137,5
D	mm	9,1	9,1	9,1	9,1	9,1	9,1	9,5	9,5	9,5	9,5	11,1	11,1	11,1	11,1	14,2	14,2	14,2
E	mm	1,5 ^{-0,1}	1,5 ^{-0,1}	1,5 ^{-0,1}	1,5 ^{-0,1}	1,5 ^{-0,1}	1,5 ^{-0,1}	1,6 ^{+0,2}	1,6 ^{+0,2}	1,6 ^{+0,2}	1,6 ^{+0,2}	2,3 ^{+0,2}	2,3 ^{+0,2}	2,3 ^{+0,2}	2,3 ^{+0,2}	2,4 ^{+0,2}	2,4 ^{+0,2}	2,4 ^{+0,2}
F	mm	33	33	33	33	33	33	35	35	35	35	32	32	32	32	37	37	37
G	mm	90	90	90	90	90	90	132	132	132	132	156	156	156	156	190	190	190
H _{+0,1}	mm	120,65	120,65	120,65	120,65	120,65	120,65	155,6	155,6	155,6	155,6	184,15	184,15	184,15	184,15	247,6	247,6	247,6
J ^{B12}	mm	12,7	12,7	12,7	12,7	12,7	12,7	9,5	9,5	9,5	9,5	11,2	11,2	11,2	11,2	16	16	16
K	mm	115	115	115	115	115	115	145	145	145	145	178	178	178	178	204	204	204
M	mm	60	60	60	60	60	60	65	65	65	65	96	96	96	96	111	111	111
S _{min}	mm	325	360	400	430	473	523	360	400	460	550	560	600	650	740	652	720	830
X (extension)	mm	35	50	60	60	60	120	40	80	80	110	45	60	110	110	80	110	140
Tooth/spline dim.	mm	42x2x20	42x2x20	42x2x20	42x2x20	42x2x20	42x2x20	55x2,5x20	55x2,5x20	55x2,5x20	55x2,5x20	75x2,5x28	75x2,5x28	75x2,5x28	75x2,5x28	90x2,5x34	90x2,5x34	90x2,5x34
Type of flange		1	1	1	1	1	1	2	2	2	2	3	3	3	3	2	2	2

β = Maximum angle of deflection per joint
S = Compressed lengths; corresponds to the length of standard type

At utilisation of the nominal torque a verification of the flange connection is necessary.

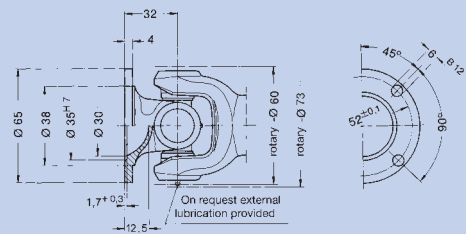

Standard flange
end number: 0.106.XX0

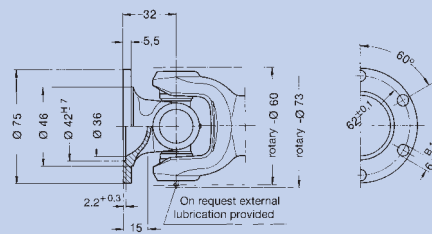

Larger flange
end number: 0.106.XX1

One keyway is not enough to transmit the max. torque. In such case a second keyway or an internal spline is recommended.

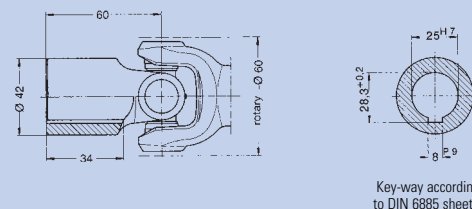

Connecting hub
without key-way end number: 0.106.XX2
with key-way end number: 0.106.XX3

Cross Units, Needle bearing version



		Standard version Needle bearing		Version suitable for external lubrication Needle bearing	
Order number		0.106.010		0.106.012	
A	mm	48		48	
B	mm	19		19	
C	mm	12,7		12,7	
Snap rings included	mm	J 19 x 1		J 19 x 1	
Weight	kg	0,14		0,144	

β = Maximum angle of deflection per joint
X = Preferred extension (larger extension available up to approx. 9 x spline o. D.)

Fixed joint

Slip joint

Slip joint (sliding sleeve type)

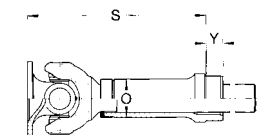
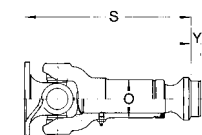
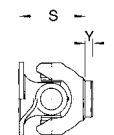

Please indicate compressed length „S“, extension and required type of flange when ordering!

	Needle bearing version											
	without extension				standard extension				larger extension			
Order number	0.106.050	0.106.051	0.106.052	-	0.106.060	0.106.061	0.106.062	-	0.106.070	0.106.071	0.106.072	-
Angle of deflection β °	30	20	30	-	30	20	30	-	30	20	30	-
Weight kg	0,56	0,65	1,30	-	1,18	1,27	1,30	-	1,25	1,34	1,37	-
Flange-Ø mm	65	75	Hub	-	65	75	Hub	-	65	75	Hub	-
S mm	64	64	92	-	167	167	195	-	177	177	205	-
X mm	-	-	-	-	30	30	30	-	60	60	60	-
Y mm	13	13	13	-	13	13	13	-	9	9	9	-
Z mm	29,25	29,25	29,25	-	29,25	29,25	29,25	-	29,25	29,25	29,25	-
Spline dim. DIN 5480 mm	-	-	-	-	25x1,5x15	25x1,5x15	25x1,5x15	-	25x1,5x15	25x1,5x15	25x1,5x15	-
Number of flange holes	4	6	-	-	4	6	-	-	4	6	-	-

At utilisation of the nominal torque a verification of the flange connection is necessary.

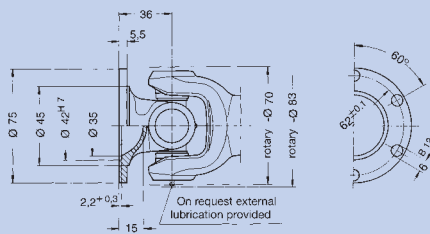

Standard flange
end number: 0.107.XX0

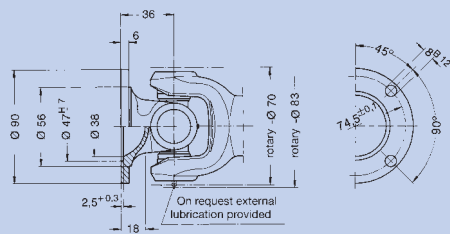

Larger flange
end number: 0.107.XX1

One keyway is not enough to transmit the max. torque. In such case a second keyway or an internal spline is recommended.

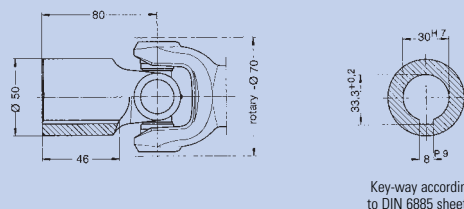

Key-way according to DIN 6885 sheet 1

Connecting hub
without key-way end number: 0.107.XX2
with key-way end number: 0.107.XX3

Cross Units, Needle bearing version



		Standard version Needle bearing		Version suitable for external lubrication Needle bearing
Order number		0.107.010		0.107.012
A	mm	58		58
B	mm	22		22
C	mm	13,35		16
Snap rings included	mm	J 22 x 1		J 22 x 1
Weight	kg	0,224		0,228

β = Maximum angle of deflection per joint
X = Preferred extension (larger extension available up to approx. 9 x spline o. D.)

Fixed joint

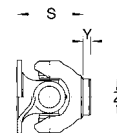

Slip joint

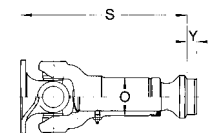

Slip joint (sliding sleeve type)

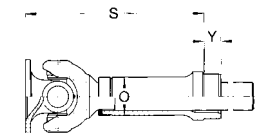

Please indicate compressed length „S“, extension and required type of flange when ordering!

	Needle bearing version											
	without extension				standard extension				larger extension			
Order number	0.107.050	0.107.051	0.107.052	–	0.107.060	0.107.061	0.107.062	–	0.107.070	0.107.071	0.107.072	–
Angle of deflection β °	30	18	30	–	30	18	30	–	30	18	30	–
Weight kg	0,91	1,06	1,25	–	1,63	1,78	1,97	–	1,98	2,13	2,32	–
Flange-Ø mm	75	90	Hub	–	75	90	Hub	–	75	90	Hub	–
S mm	82	82	126	–	187	187	231	–	197	197	241	–
X mm	–	–	–	–	35	35	35	–	70	70	70	–
Y mm	13	13	13	–	13	13	13	–	15	15	15	–
Z mm	36,25	36,25	36,25	–	36,25	36,25	36,25	–	36,25	36,25	36,25	–
Spline dim. DIN 5480	–	–	–	–	28x1,5x17	28x1,5x17	28x1,5x17	–	28x1,5x17	28x1,5x17	28x1,5x17	–
Number of flange holes	6	4	–	–	6	4	–	–	6	4	–	–

At utilisation of the nominal torque a verification of the flange connection is necessary.

One keyway is not enough to transmit the max. torque. In such case a second keyway or an internal spline is recommended.

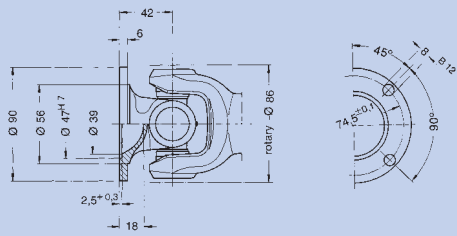

Standard flange
end number: 0.109.XX0

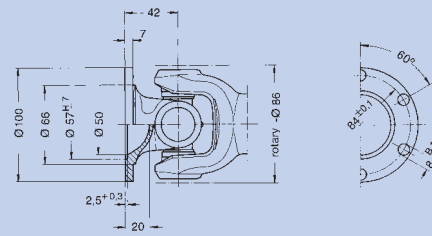

Larger flange
end number: 0.109.XX1

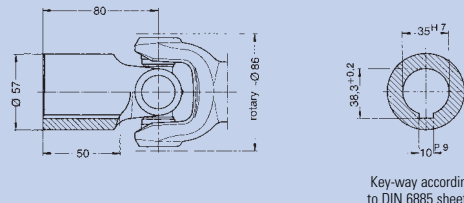

Connecting hub
without key-way end number: 0.109.XX2
with key-way end number: 0.109.XX3

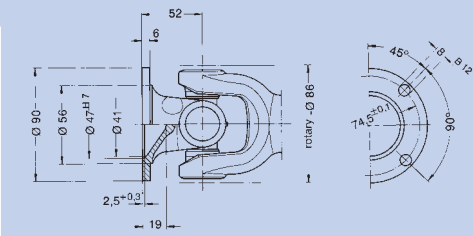

Flange for larger deflection
end number: 0.109.XX5

Cross Units, Needle bearing version

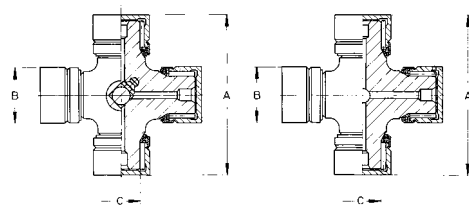

		Standard version Needle bearing	Lubrication for Version 0.100.3XX Needle bearing
Order number	0.109.010		0.109.011
A	mm	70,9	70,9
B	mm	28,5	28,5
C	mm	19,87	19,87
Snap rings included	mm	J 29 x 1,2	J 29 x 1,2
Weight	kg	0,508	0,504

β = Maximum angle of deflection per joint
X = Preferred extension (larger extension available up to approx. 9 x spline o. D.)

Fixed joint

Slip joint

Slip joint (sliding sleeve type)

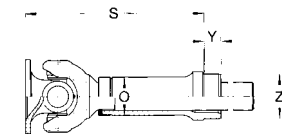
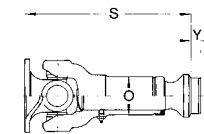
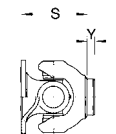

Please indicate compressed length „S“, extension and required type of flange when ordering!

	Needle bearing version											
	without extension				standard extension				larger extension			
Order number	0.109.050	0.109.051	0.109.052	0.109.055	0.109.060	0.109.061	0.109.062	0.109.065	0.109.070	0.109.071	0.109.072	0.109.075
Angle of deflection β °	20	18	20	35	20	18	20	35	20	18	20	35
Weight kg	1,82	1,93	2,21	1,90	3,01	3,12	3,40	3,12	3,39	3,50	3,78	3,61
Flange-Ø mm	90	100	Hub	90	90	100	Hub	90	90	100	Hub	90
S mm	90	90	128	100	225	225	263	242	222	222	260	241
X mm	-	-	-	-	40	40	40	40	80	80	80	80
Y mm	14	14	14	14	15	15	15	15	18	18	18	18
Z mm	46,25	46,25	46,25	46,25	46,25	46,25	46,25	46,25	46,25	46,25	46,25	46,25
Spline dim. DIN 5480 mm	-	-	-	-	32x2x14	32x2x14	32x2x14	32x2x14	32x2x14	32x2x14	32x2x14	32x2x14
Number of flange holes	4	6	-	4	4	6	-	4	4	6	-	4

At utilisation of the nominal torque a verification of the flange connection is necessary.

One keyway is not enough to transmit the max. torque. In such case a second keyway or an internal spline is recommended.

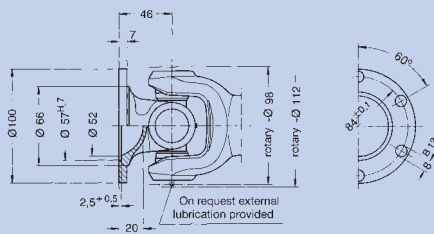

Standard flange
end number: 0.110.XX0

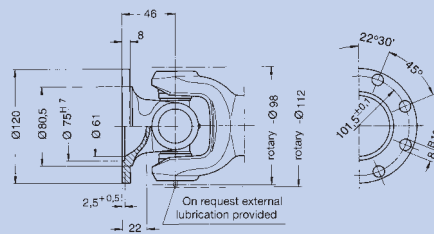

Larger flange
end number: 0.110.XX1

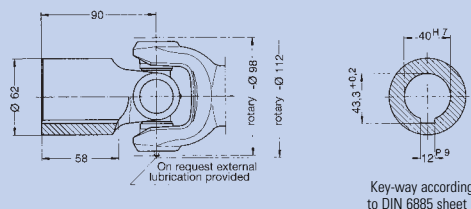

Connecting hub
without key-way end number: 0.110.XX2
with key-way end number: 0.110.XX3

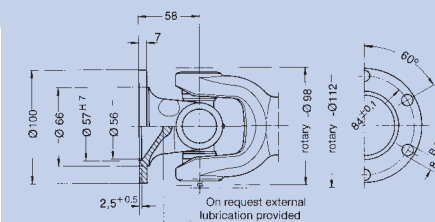

Flange for larger deflection
end number: 0.110.XX5

Cross Units, Roller bearing version

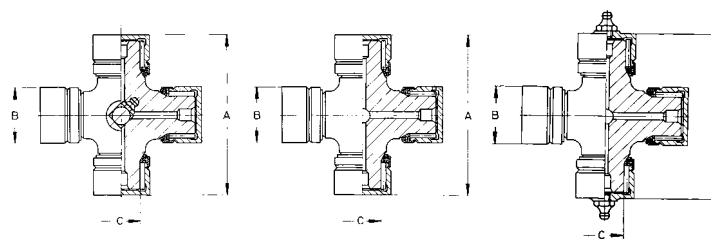

		Standard version Roller bearing	Lubrication for version 0.100.3XX Roller bearing	Version suitable for external lubrication Roller bearing
Order number		0.110.015	0.110.017	0.110.016
A	mm	83	83,05	83
B	mm	30	30	30
C	mm	20,02	20,02	20,02
Snap rings included	mm	J 30 x 1,2	J 30 x 1,2	J 30 x 1,2
Weight	kg	0,66	0,65	0,66

β = Maximum angle of deflection per joint
X = Preferred extension (larger extension available up to approx. 9 x spline o. D.)

Fixed joint

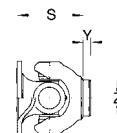

Slip joint

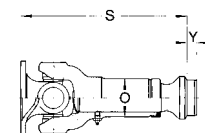

Slip joint (sliding sleeve type)

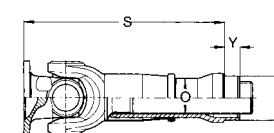

Please indicate compressed length „S“, extension and required type of flange when ordering!

	Roller bearing version											
	without extension				standard extension				larger extension			
Order number	0.110.050	0.110.051	0.110.052	0.110.055	0.110.060	0.110.061	0.110.062	0.110.065	0.110.070	0.110.071	0.110.072	0.110.075
Angle of deflection β °	20	18	20	35	20	18	20	35	20	18	20	35
Weight kg	2,38	2,60	2,75	2,45	3,83	4,06	4,20	4,01	4,70	4,92	5,07	4,77
Flange-Ø mm	100	120	Hub	100	100	120	Hub	100	100	120	Hub	100
S mm	105	105	149	117	237	237	281	256	244	244	288	256
X mm	-	-	-	-	40	40	40	40	100	100	100	100
Y mm	15	15	15	15	15	15	15	15	18	18	18	18
Z mm	44,25	44,25	44,25	44,25	44,25	44,25	44,25	44,25	44,25	44,25	44,25	44,25
Spline dim. DIN 5480 mm	-	-	-	-	35x2x16	35x2x16	35x2x16	35x2x16	35x2x16	35x2x16	35x2x16	35x2x16
Number of flange holes	6	8	-	6	6	8	-	6	6	8	-	6

At utilisation of the nominal torque a verification of the flange connection is necessary.

One keyway is not enough to transmit the max. torque. In such case a second keyway or an internal spline is recommended.

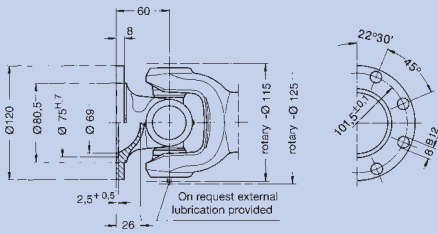

Standard flange
end number: 0.112.XX0

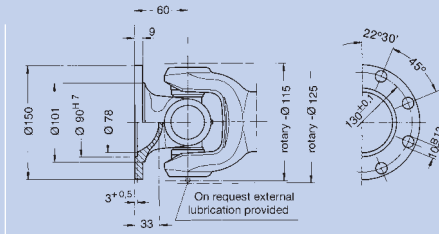

Larger flange
end number: 0.112.XX1

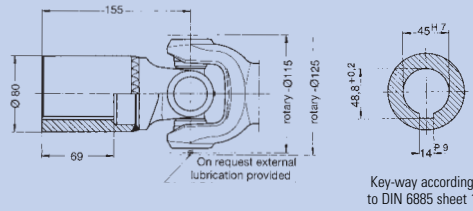

Connecting hub
without key-way end number: 0.112.XX2
with key-way end number: 0.112.XX3

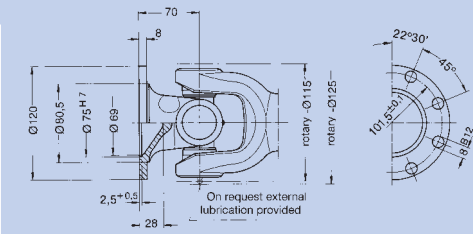

Flange for larger angle of deflection
end number: 0.112.XX5

Cross Units

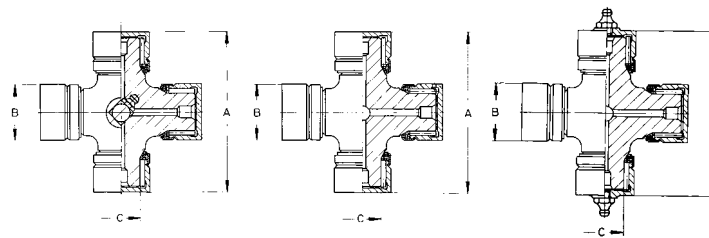

	Needle bearing version		
	Standard version Needle bearing	Lubrication for version 0.100.3XX Needle bearing	Version suitable for external lubrication Needle bearing
Order number	0.112.010	0.112.011	0.112.012
A	mm 97	mm 97	mm 97
B	mm 35	mm 35	mm 35
C	mm 23,04	mm 23,04	mm 23,04
Snap rings included	mm J 35 x 1,5	mm J 35 x 1,5	mm J 35 x 1,5
Weight	kg 1,03	kg 1,02	kg 1,03

	Roller bearing version		
	Standard version Roller bearing	Lubrication for version 0.100.3XX Roller bearing	Version suitable for external lubrication Roller bearing
Order number	0.112.015	0.112.017	0.112.016
A	mm 97	mm 97	mm 97
B	mm 35	mm 35	mm 35
C	mm 24,8	mm 24,8	mm 24,8
Snap rings included	mm J 35 x 1,5	mm J 35 x 1,5	mm J 35 x 1,5
Weight	kg 1,06	kg 1,05	kg 1,06

β = Maximum angle of deflection per joint
X = Preferred extension (larger extension available up to approx. 9 x spline o. D.)

Fixed joint

Slip joint

Slip joint (sliding sleeve type)

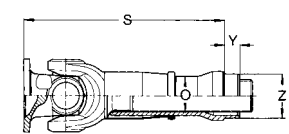
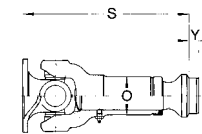
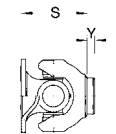

Please indicate compressed length „S“, extension and required type of flange when ordering!

	Needle resp. Roller bearing version											
	without extension				standard extension				larger extension			
Order number	0.112.050	0.112.051	0.112.052	0.112.055	0.112.060	0.112.061	0.112.062	0.112.065	0.112.070	0.112.071	0.112.072	0.112.075
Angle of deflection β °	20	18	20	35	20	18	20	35	20	18	20	35
Weight kg	3,80	4,48	6,09	3,93	6,63	7,31	8,92	6,73	7,26	7,94	9,55	7,94
Flange-Ø mm	120	150	Hub	120	120	150	Hub	120	120	150	Hub	120
S mm	125	125	220	135	306	306	401	330	308	308	403	325
X mm	-	-	-	-	60	60	60	60	120	120	120	120
Y mm	20	20	20	20	20	20	20	20	20	20	20	20
Z mm	52,25	52,25	52,25	52,25	52,25	52,25	52,25	52,25	52,25	52,25	52,25	52,25
Spline dim. DIN 5480 mm	-	-	-	-	42 x 2 x 20	42 x 2 x 20	42 x 2 x 20	42 x 2 x 20	42 x 2 x 20	42 x 2 x 20	42 x 2 x 20	42 x 2 x 20
Number of flange holes	8	8	-	8	8	8	-	8	8	8	-	8

At utilisation of the nominal torque a verification of the flange connection is necessary.

One keyway is not enough to transmit the max. torque. In such case a second keyway or an internal spline is recommended.

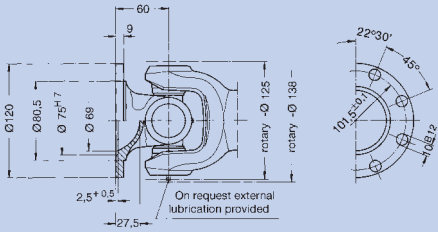

Standard flange
end number: 0.113.XX0

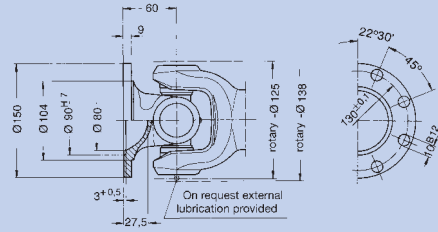

Larger flange
end number: 0.113.XX1

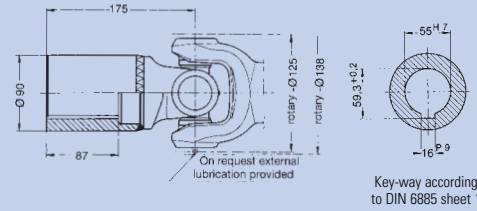

Connecting hub
without key-way end number: 0.113.XX2
with key-way end number: 0.113.XX3

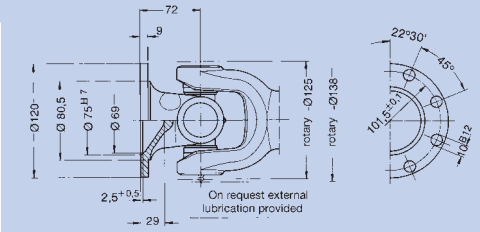

Flange for larger angle of deflection
end number: 0.113.XX5

Cross Units

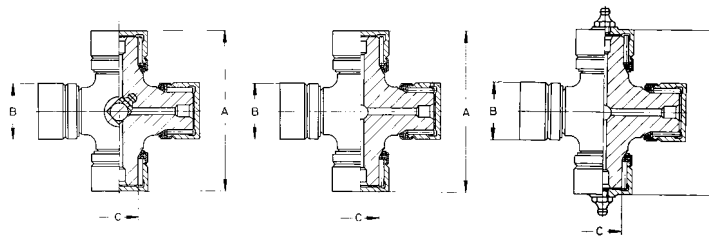

β = Maximum angle of deflection per joint
X = Preferred extension (larger extension available up to approx. 9 x spline o. D.)

Fixed joint

Slip joint

Slip joint (sliding sleeve type)

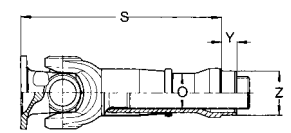
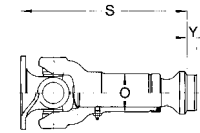
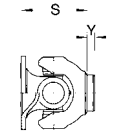

		Needle bearing version		
		Standard version Needle bearing	Lubrication for version 0.100.3XX Needle bearing	Version suitable for external lubrication Needle bearing
Order number		0.113.010	0.113.011	0.113.012
A	mm	106	106	106
B	mm	38	38	38
C	mm	26,28	26,28	26,28
Snap rings included	mm	J 38 x 1,5	J 38 x 1,5	J 38 x 1,5
Weight	kg	1,32	1,32	1,33

		Roller bearing version	
		Standard version Roller bearing	Version suitable for external lubrication Roller bearing
Order number		0.113.015	0.113.016
A	mm	106	106
B	mm	38	38
C	mm	25,7	25,7
Snap rings included	mm	J 38 x 1,5	J 38 x 1,5
Weight	kg	1,25	1,34

Please indicate compressed length „S“, extension and required type of flange when ordering!

Needle resp. Roller bearing version

	without extension				standard extension				larger extension			
	0.113.050	0.113.051	0.113.052	0.113.055	0.113.060	0.113.061	0.113.062	0.113.065	0.113.070	0.113.071	0.113.072	0.113.075
Order number												
Angle of deflection β °	20	18	20	35	20	18	20	35	20	18	20	35
Weight	4,52	5,20	7,63	4,85	8,85	9,53	11,96	9,40	10,24	10,92	13,35	10,57
Flange-Ø	120	150	Hub	120	120	150	Hub	120	120	150	Hub	120
S	128	128	243	140	318	318	433	343	320	320	435	332
X	-	-	-	-	60	60	60	60	130	130	130	130
Y	20	20	20	20	22	22	22	22	22	22	22	22
Z	62,25	62,25	62,25	62,25	62,25	62,25	62,25	62,25	62,25	62,25	62,25	62,25
Spline dim. DIN 5480	-	-	-	-	50x2x24	50x2x24	50x2x24	50x2x24	50x2x24	50x2x24	50x2x24	50x2x24
Number of flange holes	8	8	-	8	8	8	-	8	8	8	-	8

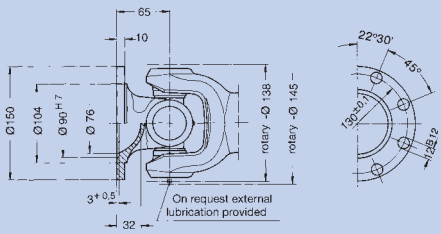

Standard flange
end number: 0.148.XX0

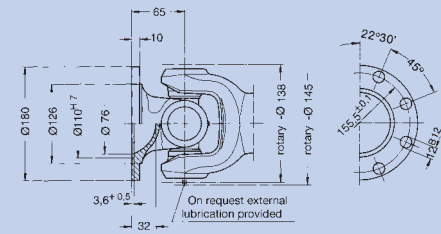

Larger flange
end number: 0.148.XX1

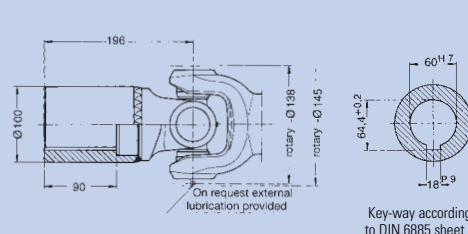

Connecting hub
without key-way end number: 0.148.XX2
with key-way end number: 0.148.XX3

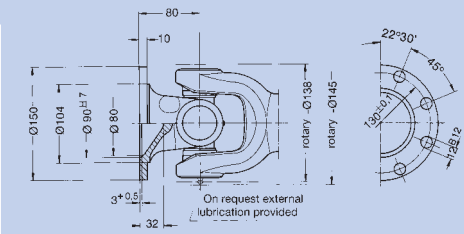

Flange for larger angle of deflection
end number: 0.148.XX5

Cross Units, Roller bearing version



Order number	Standard version Roller bearing	Version suitable for external lubrication Roller bearing
A	mm 117,5	mm 117,5
B	mm 42	mm 42
C	mm 27,8	mm 27,8
Snap rings included	mm J 42 x 1,75	mm J 42 x 1,75
Weight	kg 1,69	kg 1,7

β = Maximum angle of deflection per joint
X = Preferred extension (larger extension available up to approx. 9 x spline o. D.)

Fixed joint

Slip joint (sliding sleeve type)

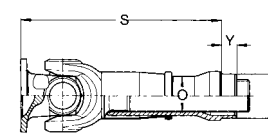
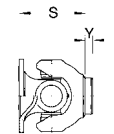

Please indicate compressed length „S“, extension and required type of flange when ordering!

	Roller bearing version							
	without extension				larger extension			
Order number	0.148.050	0.148.051	0.148.052	0.148.055	0.148.070	0.148.071	0.148.072	0.148.075
Angle of deflection β °	20	20	35	35	20	20	20	35
Weight kg	7,06	7,71	11,51	7,72	13,23	13,88	17,68	13,89
Flange-Ø mm	150	180	Hub	120/150	150	180	Hub	120/150
S mm	145	145	276	160	328	328	459	343
X mm	-	-	-	-	110	110	110	110
Y mm	25	25	25	25	25	25	25	25
Z mm	72,25	72,25	72,25	72,25	72,25	72,25	72,25	72,25
Spline dim. DIN 5480	-	-	-	-	55x2,5x20	55x2,5x20	55x2,5x20	55x2,5x20
Number of flange holes	8	8	-	8	8	8	-	8

At utilisation of the nominal torque a verification of the flange connection is necessary.

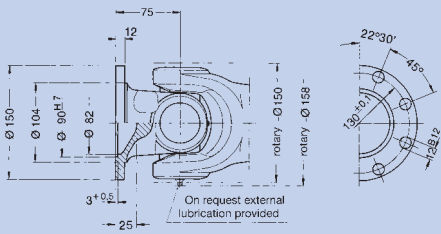

Standard flange
end number: 0.158.XX0

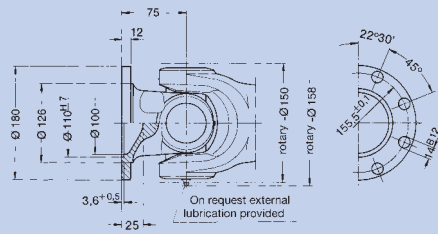

Larger flange
end number: 0.158.XX1

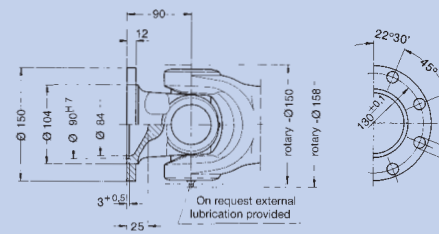

Flange for larger deflection
end number: 0.158.XX5

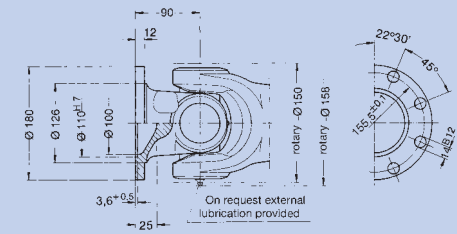

Larger flange for larger deflection
end number: 0.158.XX6

Cross Units, Roller bearing version



		Standard version Roller bearing	Version suitable for external lubrication Roller bearing
Order number	0.158.015		0.158.016
A	mm	126	126
B	mm	48	48
C	mm	33,15	33,15
Snap rings included	mm	J 48 x 1,75	J 48 x 1,75
Weight	kg	2,28	2,29

β = Maximum angle of deflection per joint
X = Preferred extension (larger extension available up to approx. 9 x spline o. D.)

Fixed joint

Slip joint (sliding sleeve type)

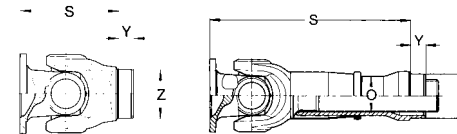

Please indicate compressed length „S“, extension and required type of flange when ordering!

	Roller bearing version							
	without extension				larger extension			
Order number	0.158.050	0.158.051	0.158.055	0.158.056	0.158.070	0.158.071	0.158.075	0.158.076
Angle of deflection β °	20	20	35	35	20	20	35	35
Weight	10,12	10,90	10,55	11,36	20,78	21,56	21,21	22,02
Flange-Ø	150	180	150	180	150	180	150	180
S	185	185	200	200	475	475	490	490
X	—	—	—	—	110	110	110	110
Y	22	22	22	22	25	25	25	25
Z	82,25	82,25	82,25	82,25	82,25	82,25	82,25	82,25
Spline dim. DIN 5480	—	—	—	—	60x2,5x22	60x2,5x22	60x2,5x22	60x2,5x22
Number of flange holes	8	8	8	8	8	8	8	8

At utilisation of the nominal torque a verification of the flange connection is necessary.

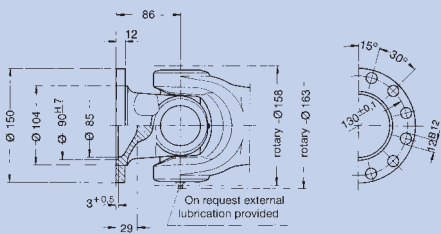

Standard flange
end number: 0.117.XX0

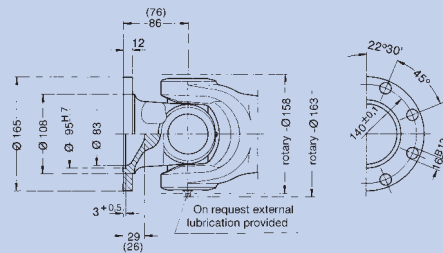

Larger flange (Ø 165 mm)
end number: 0.117.XX1

Dimensions in brackets are only valid for short type I

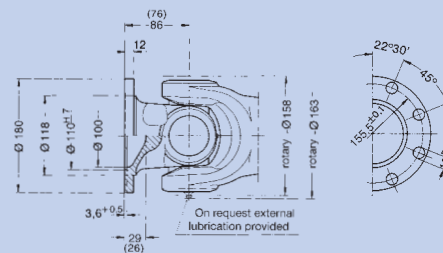

Larger flange (Ø 180 mm)
end number: 0.117.XX1

Dimensions in brackets are only valid for short type I

Cross Units, Roller bearing version



		Standard version Roller bearing	Version suitable for external lubrication Roller bearing
Order number		0.117.015	0.117.016
A	mm	135	135
B	mm	53	53
C	mm	37,34	37,34
Snap rings included	mm	J 53 x 2	J 53 x 2
Weight	kg	3,26	3,28

β = Maximum angle of deflection per joint
X = Preferred extension (larger extension available up to approx. 9 x spline o. D.)

Fixed joint

Slip joint (sliding sleeve type)

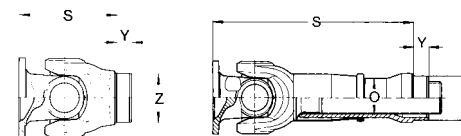

Please indicate compressed length „S“, extension and required type of flange when ordering!

	Roller bearing version							
	without extension				larger extension			
Order number	0.117.050	0.117.051	0.117.051	–	0.117.070	0.117.071	0.117.071	–
Angle of deflection β °	30	30	30	–	30	30	30	–
Weight kg	12,29	12,52	13,06	–	21,99	22,13	22,75	–
Flange-Ø mm	150	165	180	–	150	165	180	–
S mm	184	184	184	–	412/(457)	412/(457)	412/(457)	–
X mm	–	–	–	–	110	110	110	–
Y mm	28	28	28	–	30	30	30	–
Z mm	90,25	90,25	90,25	–	90,25	90,25	90,25	–
Spline dim. DIN 5480 mm	–	–	–	–	65x2,5x24	65x2,5x24	65x2,5x24	–
Number of flange holes	12	8	8	–	12	8	8	–

At utilisation of the nominal torque a verification of the flange connection is necessary.

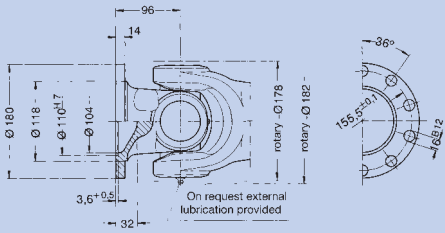

Standard flange
end number: 0.120.XX0

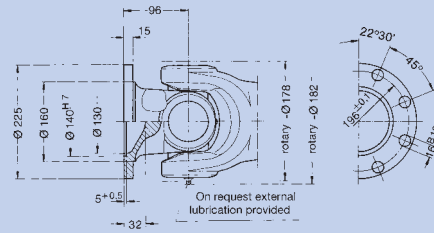

Larger flange
end number: 0.120.XX1

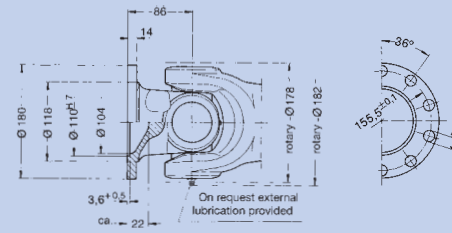

Shorter flange to short type I

Cross Units, Roller bearing version



		Standard version Roller bearing		Version suitable for external lubrication Roller bearing	
Order number		0.120.015		0.120.016	
A	mm	152		152	
B	mm	57		57	
C	mm	40,9		40,9	
Snap rings included	mm	J 57 x 2		J 57 x 2	
Weight	kg	4,19		4,21	

β = Maximum angle of deflection per joint
X = Preferred extension (larger extension available up to approx. 9 x spline o. D.)

Fixed joint

Slip joint (sliding sleeve type)

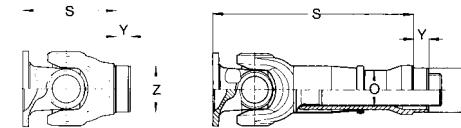

Please indicate compressed length „S“, extension and required type of flange when ordering!

	Roller bearing version							
	without extension				larger extension			
Order number	0.120.050	0.120.051	-	-	0.120.070	0.120.071	-	-
Angle of deflection β °	30	30	-	-	30	30	-	-
Weight kg	16,47	18,54	-	-	30,88	32,95	-	-
Flange-Ø mm	180	225	-	-	180	225	-	-
S mm	201	201	-	-	448/(486)	448/(486)	-	-
X mm	-	-	-	-	110	110	-	-
Y mm	30	30	-	-	30	30	-	-
Z mm	98,25	98,25	-	-	98,25	98,25	-	-
Spline dim. DIN 5480	-	-	-	-	75x2,5x28	75x2,5x28	-	-
Number of flange holes	10	8	-	-	10	8	-	-

At utilisation of the nominal torque a verification of the flange connection is necessary.

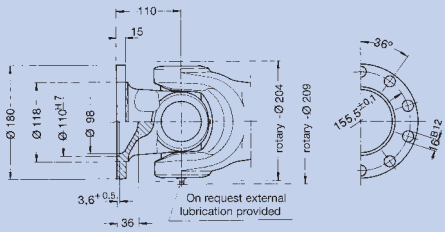

Standard flange
end number: 0.122.XX0

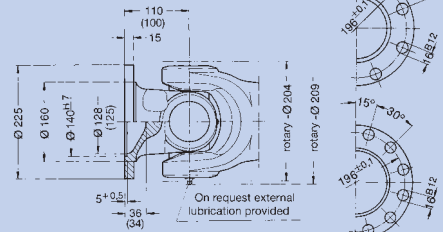

Larger flange (Ø 225 mm)
end number: 0.122.XX1

Dimensions in brackets are only valid for short type I

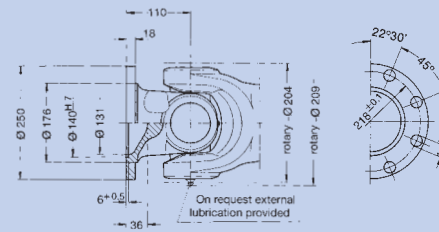

Larger flange (Ø 250 mm)
end number: 0.122.XX1

Cross Units, Roller bearing version



		Standard version Roller bearing		Version suitable for external lubrication Roller bearing
Order number	0.122.015			0.122.016
A	mm	172		172
B	mm	65		65
C	mm	47,7		47,7
Snap rings included	mm	J 65 x 2,5		J 65 x 2,5
Weight	kg	6,15		6,17

β = Maximum angle of deflection per joint
X = Preferred extension (larger extension available up to approx. 9 x spline o. D.)

Fixed joint

Slip joint (sliding sleeve type)

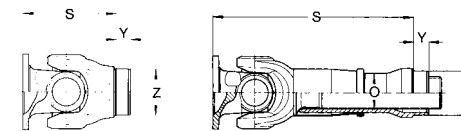

Please indicate compressed length „S“, extension and required type of flange when ordering!

	Roller bearing version							
	without extension				larger extension			
Order number	0.122.050	0.122.051	0.122.051	0.122.051	0.122.070	0.122.071	0.122.071	0.122.071
Angle of deflection β °	30	30	30	25	30	30	30	25
Weight kg	22,26	24,70	24,65	26,32	47,95	50,39	50,34	52,00
Flange-Ø mm	180	225	225	250	180	225	225	250
S mm	225	225	225	225	496	496	496	496
X mm	-	-	-	-	140	140	140	140
Y mm	30	30	30	30	28	28	28	28
Z mm	108,25	108,25	108,25	108,25	108,25	108,25	108,25	108,25
Spline dim. DIN 5480	-	-	-	-	90x2,5x34	90x2,5x34	90x2,5x34	90x2,5x34
Number of flange holes	10	8	12	8	10	8	12	8

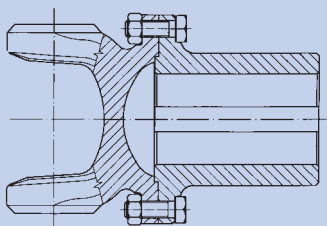

The tightening torque listed in the table are maximum values which are based on the combined stress from tension and torsion to reach 90 % of the minimum yield value. They are only valid for normal surface finishes and when slight lubrication is applied to the thread and contact surfaces of bolt heads and nuts. If threads have received special treatment, tightening torques must be reduced accordingly. To achieve maximum friction, flange faces should be clean, free of lubrication and the surface finish should not exceed 25 µm.

Bolts are normally inserted from the companion flange side and turned diameter „C” serves as a bolt head lock. Only on certain Universal Joint sizes can the bolts be inserted from the Universal Joint side without any reworking.

When encountering distinct reversing operation, it is advisable to reinforce the bolts with adapter sleeves or to employ serrated flanges.

The indicated numbers per Kit refer to a drive shaft having 2 flanges.

One keyway is not enough to transmit the max. torque. In such case a second keyway or an internal spline is recommended.

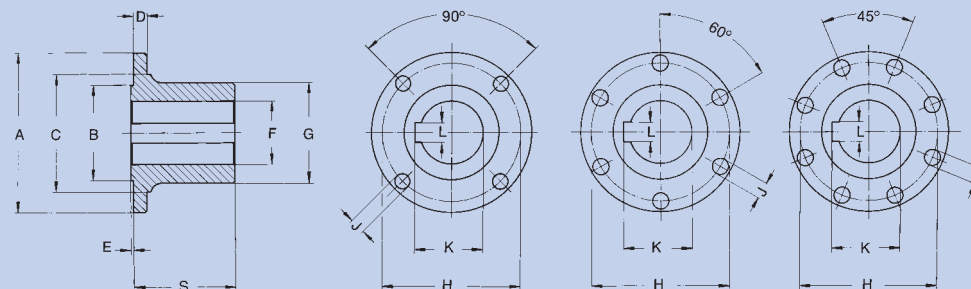

Flange bolt Kit

Order number	0.105.192.001	0.106.192.001	0.107.192.001	0.109.192.001	0.110.192.001	0.112.192.001	0.113.192.001	0.148.192.001	0.158.192.001	0.117.192.001
for joint size	105	105/106	106/107	107/109	109/110	110/112	112/113	148	158	117
Flange-Ø A	58	65	75	90	100	120	120/150	150/180	150/180	150
Hexagon head bolts DIN EN 240 14-10.9	M5 x 14	M6 x 18	M6 x 18	M8 x 24	M8 x 24	M8 x 26	M10 x 30	M12 x 35	M12 x 40	M12 x 40
Number per Kit	8	8	12	8	12	16	16	16	16	24
Hexagon head bolts DIN EN ISO 7042-10	M5	M6	M6	M8	M8	M8	M10	M12	M12	M12
Number per Kit	8	8	12	8	12	16	16	16	16	24
Tightening torque	8,5	14	14	35	35	35	69	120	120	120

Order number	0.117.192.002	0.117.192.003	0.120.192.001	0.120.192.002	0.122.192.002	0.122.192.003
for joint size	117	158/117	120/122	120/122	120/122	122
Flange-Ø A	165/180	165/180	180	180/225	225	250
Hexagon head bolts DIN EN 240 14-10.9	M16 x 46	M14 x 42	M16 x 50	M16 x 50	M16 x 50	M18 x 60
Number per Kit	16	16	20	16	24	16
Hexagon head bolts DIN EN ISO 7042-10	M16	M14	M16	M16	M16	M18
Number per Kit	16	16	20	16	24	16
Tightening torque	295	190	295	295	295	450

Flange with cross serration

Order number	0.112.192.003	0.158.192.005	0.117.192.008
for joint size	112/113/148	158/117	117/120/122
Flange-Ø A	120	150	180
Hexagon head bolts DIN EN 240 14-10.9	M10 x 40	M12 x 40	M14 x 45
Number per Kit	8	8	8
Hexagon head bolts DIN EN ISO 7042-10	M10	M12	M14
Number per Kit	8	8	8
Tightening torque	46	79	125

Companion Flanges

Order number	1.105.240	1.106.240	1.107.240	1.109.240	1.110.240	1.112.240	1.113.240	1.148.240	1.158.240	1.117.240	1.120.240	1.122.240
for joint size	0.105	0.106/0.105	0.107/0.106	0.109/0.107	0.110/0.109	0.112/0.110	0.113	0.148	0.158	0.117	0.120	0.122
A	58	65	75	90	100	120	120	150	150	180	225	250
B _{H6}	30	35	42	47	57	75	75	90	90	110	140	140
C _{-0,2}	38,8	41,8	51,8	61,2	70,7	88,2	84,1	110,6	110,6	131	171,5	190
D	4	5	6	8	8	9	10	10	12	14	15	18
E _{-0,2}	1,4	1,6	1,9	2,3	2,3	2,3	2,3	2,8	2,8	2,8	4,5	5,5
F ^{H7}	20	25	30	35	40	45	55	60	65	80	110	110
G	32	40	45	52	60	80	80	95	95	118	165	188
H ^{+0,1}	47	52	62	74,5	84	101,5	101,5	130	130	155,5	196	218
J ^{B12}	5	6	6	8	8	8	10	12	12	16	16	18
K	22,8	28,3	33,3	38,3	43,3	48,8	59,3	64,4	69,4	85,4	116,4	116,4
L ^{P8}	6	8	8	10	12	14	16	18	18	22	28	28
S	30	40	48	55	62	70	85	100	115	125	170	280
Number of flange holes	4	4	6	4	6	8	8	8	8	8	8	8

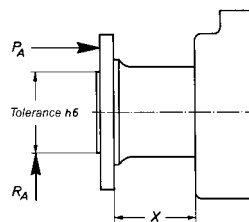

When companion flanges are produced in-house, the following should be observed:

1. Flange surface finish should not exceed 25 µm.
2. The configuration of the companion flanges must be such, that distance „X” is at least as long as the bolt, included the head.
3. To operate in a trouble-free manner, there must be a good concentricity between the companion flanges and Universal Joint flanges. On high speed shafts face P_A run out and concentricity deviation R_A should not exceed 0,04 mm .

Md_{Nom} 3350–26750 Nm

Md_{Lim} 4350–35000 Nm

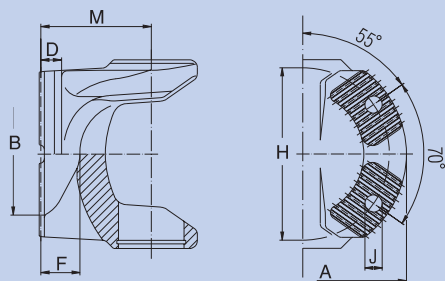

β = Maximum angle of deflection per joint
Cross serration according DIN ISO 8667

Flanges, Cross-serrated

Order number		1.112.302	1.113.302	1.148.302	1.158.302	1.117.302	1.117.302	1.120.302	1.122.302
Md_{Nom}	Nm	3350	4100	5500	8200	10000	10000	16850	26750
Angle of deflection β	°	20	20	30	20	30	30	30	30
A approx.	mm	122	120	120	150	150	180	180	180
B	mm	72	72	72	92	93	106	106	106
D_{+1}	mm	13	13	13	15,5	15,5	18	18	19
F approx.	mm	26	37	24	28	33	33	34	34
$H_{\pm 0,1}$	mm	100	100	100	130	130	150	150	150
J	mm	11	11	11	13	13	15	15	15
M	mm	60	70	70	75	90	90	96	100
Weight	kg	1,83	2,10	2,37	3,36	4,40	5,32	6,36	7,36

Needle bearing version

One keyway is not enough to transmit the max. torque. In such case a second keyway or an internal spline is recommended.

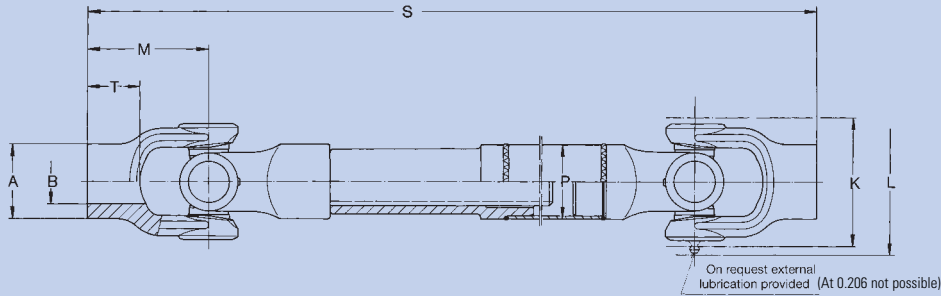

On both sides connecting hub without key-way end number: 0.204.XX0
0.204.XX1

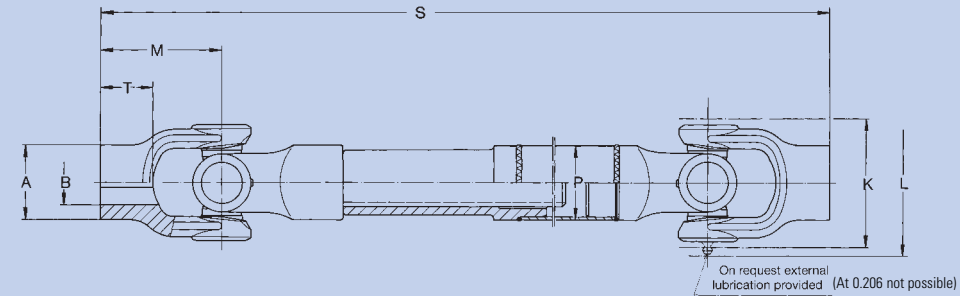

On both sides connecting hub with key-way end number: 0.204.XX3 Key-way according to DIN 6885 sheet 1
0.204.XX4

Please indicate compressed length „S“, extension and max. r.p.m. when ordering!

Universal Cardan Drive-Shafts with lenght compensation, without key-way

Order number		0.204.100	0.206.100	0.206.101	0.210.100
Md _{max}	Nm	100	250	250	1300
Angle of deflection β	°	35	45	45	45
A approx.	mm	32	43	50	62
B ^{H7}	mm	18	25	30	40
K approx.	mm	44	60	60	98
L approx.	mm	58	–	–	112
M	mm	45	60	75	115
P	mm	32x1,5	40x2	40x2	50x3
S _{min}	mm	260	337	367	655
T	mm	22	30	42	63
X	mm	45	35	35	100
Spline dim. DIN 5480	mm	20x1,5x12	25x1,5x15	25x1,5x15	35x2x16
G (at S _{min})	kg	1,18	2,28	2,77	9,78
G/100 mm standard tube	kg	0,11	0,14	0,14	0,35
G/100 mm extension	kg	0,20	0,31	0,31	0,63

Md_{max} = Maximum permitted torque. See technical annex
β = Maximum angle of deflection
G = Weight (kg)
S_{min} = Minimum compressed length for preferend extension range
X = Preferred extension (larger extensions available up to approx. 10 x spline o. D.)

Please indicate compressed length „S“, extension and max. r.p.m. when ordering!

Universal Cardan Drive-Shafts with lenght compensation, with key-way on both sides

Order number		0.204.103	0.206.103	0.206.104	0.210.103
Md _{max}	Nm	100	250	250	1300
Angle of deflection β	°	35	45	45	45
A approx.	mm	32	43	50	62
B ^{H7}	mm	18	25	30	40
K approx.	mm	44	60	60	98
L approx.	mm	58	–	–	112
M	mm	45	60	75	115
P	mm	32x1,5	40x2	40x2	50x3
S _{min}	mm	260	337	367	655
T	mm	22	30	42	63
X	mm	45	35	35	100
Spline dim. DIN 5480	mm	20x1,5x12	25x1,5x15	25x1,5x15	35x2x16
G (at S _{min})	kg	1,18	2,28	2,77	9,78
G/100 mm standard tube	kg	0,11	0,14	0,14	0,35
G/100 mm extension	kg	0,20	0,31	0,31	0,63

Md_{max} = Maximum permitted torque. See technical annex
β = Maximum angle of deflection
G = Weight (kg)
S_{min} = Minimum compressed length for preferend extension range
X = Preferred extension (larger extensions available up to approx. 10 x spline o. D.)

One keyway is not enough to transmit the max. torque. In such case a second keyway or an internal spline is recommended.

Cross Units

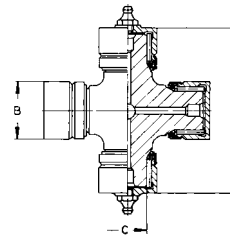
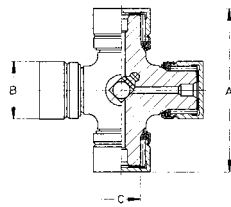

(At 0.206 not possible)

		Needle bearing version			Version for external lubrication Needle Bearing
		Standard version Needle Bearing			Version for external lubrication Needle Bearing
Order number		0.204.010	0.106.010		0.204.012
A	mm	36	48		36
B	mm	14	19		14
C	mm	7,7	12,7		7,7
Snap rings included	mm	J 14 x 1	J 19 x 1		J 14 x 1
Weight	kg	0,064	0,143		0,669
used for		0.204	0.206		0.204

		Roller bearing version			Version for external lubrication Roller Bearing
		Standard version Roller Bearing			Version for external lubrication Roller Bearing
Order number		0.110.015			0.110.016
A	mm	83			83
B	mm	30			30
C	mm	20,02			20,02
Snap rings included	mm	J 30 x 1,2			J 30 x 1,2
Weight	kg	0,66			0,66
used for		0.210			0.210

Md_{max} = Maximum permitted torque.
See technical appenage
β = Maximum angle of deflection
G = Weight (kg)

Cardan-Joints single, without key-way **Cardan-Joints single, with key-way**

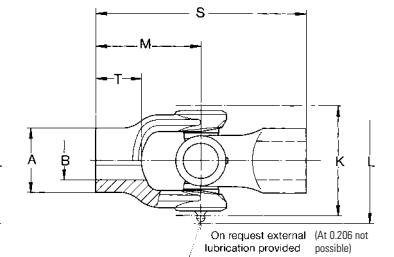
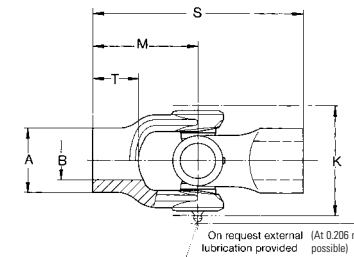

Key-way according to DIN 6885 sheet 1

		Needle bearing version									
		0.204.400	0.204.410	0.206.400	0.206.410	0.210.400	0.204.403	0.204.413	0.206.403	0.206.413	0.210.403
Order number											
Md _{max}	Nm	100	100	250	250	1300	100	100	250	250	1300
Angle of deflection β	°	45	35	45	45	45	45	35	45	45	45
A approx.	mm	35	32	50	43	62	35	32	50	43	62
B ^{H7}	mm	18	18	30	25	40	18	18	30	25	40
K approx.	mm	44	44	60	60	98	44	44	60	60	98
L approx.	mm	58	58	–	–	112	58	58	–	–	112
M	mm	54	45	75	60	115	54	45	75	60	115
S	mm	108	90	150	120	230	108	90	150	120	230
T	mm	35	22	42	30	63	35	22	42	30	63
G (at S)	kg	0,43	0,34	1,22	0,73	3,37	0,43	0,34	1,22	0,73	3,37

One keyway is not enough to transmit the max. torque. In such case a second keyway or an internal spline is recommended.

Md_{max} = Maximum permitted torque.
See technical appendage
β = Maximum angle of deflection

Fixed Joints, without key-way

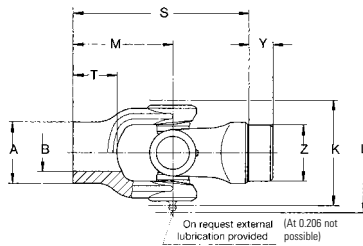

Fixed Joints, with key-way

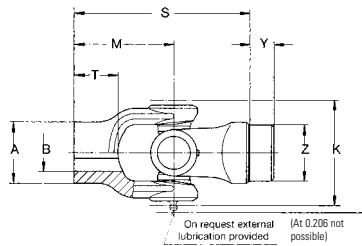

Key-way according to DIN 6885 sheet 1

Needle bearing version

Order number		0.204.050	0.206.050	0.206.051	0.210.050	0.204.053	0.206.053	0.206.054	0.210.053
Md _{max}	Nm	100	250	250	1300	100	250	250	1300
Angle of deflection β	°	35	45	45	45	35	45	45	45
Weight	kg	0,34	0,82	1,07	3,16	0,34	0,82	1,07	3,16
A approx.	mm	32	43	50	62	32	43	50	62
B ^{H7}	mm	18	25	30	40	18	25	30	40
K approx.	mm	44	60	60	98	44	60	60	98
L approx.	mm	58	–	–	112	58	–	–	112
M	mm	45	60	75	115	45	60	75	115
S	mm	74	100	115	185	74	100	115	185
T	mm	22	30	42	63	22	30	42	63
Y	mm	7	20	20	20	7	20	20	20
Z _{k,β}	mm	29,25	37,25	37,25	44,25	29,25	37,25	37,25	44,25

Md_{max} = Maximum permitted torque.
See technical appendage
β = Maximum angle of deflection
X = Preferred extension
(larger extensions available up to approx. 10 x spline o. D.)
G = Weight (kg)

Slip Joints, without key-way

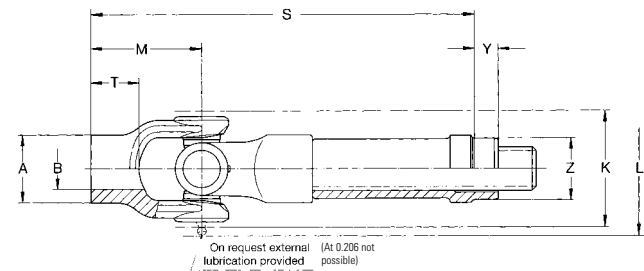

Slip Joints, with key-way

Key-way according to DIN 6885 sheet 1

Needle bearing version

Order number		0.204.070	0.206.070	0.206.071	0.210.070	0.204.073	0.206.073	0.206.074	0.210.073
Md _{max}	Nm	100	250	250	1300	100	250	250	1300
Angle of deflection β	°	35	45	45	45	35	45	45	45
Weight	kg	0,80	1,39	1,63	6,28	0,80	1,39	1,63	6,28
G/100 mm standard tube	kg	0,20	0,31	0,31	0,63	0,20	0,31	0,31	0,63
A approx.	mm	32	43	50	62	32	43	50	62
B ^{H7}	mm	18	25	30	40	18	25	30	40
K approx.	mm	44	60	60	98	44	60	60	98
L	mm	52	–	–	112	52	–	–	112
M	mm	45	60	75	115	45	60	75	115
S	mm	158	190	205	371	158	190	205	371
T	mm	22	30	42	63	22	30	42	63
X	mm	45	35	35	100	45	35	35	100
Y	mm	18	15	15	18	18	15	15	18
Z _{k,β}	mm	29,25	37,25	37,25	44,25	29,25	37,25	37,25	44,25
Spline dim. DIN 5480	mm	20x1,5x12	25x1,5x15	25x1,5x15	35x2x16	20x1,5x12	25x1,5x15	25x1,5x15	35x2x16

Please indicate extension range when ordering!

Roller bearing version

One keyway is not enough to transmit the max. torque. In such case a second keyway or an internal spline is recommended.

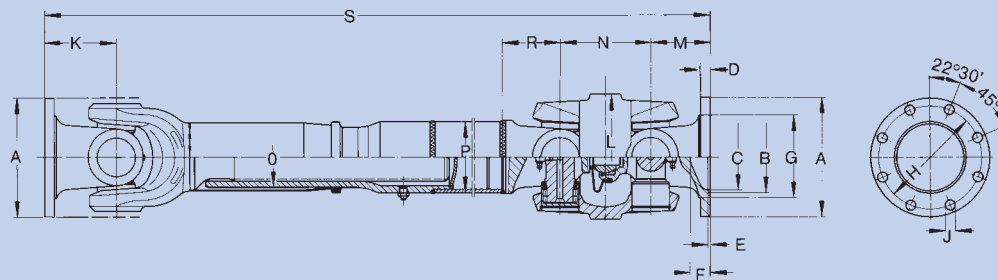

Single joint and centered double joint connected with each other by length extension

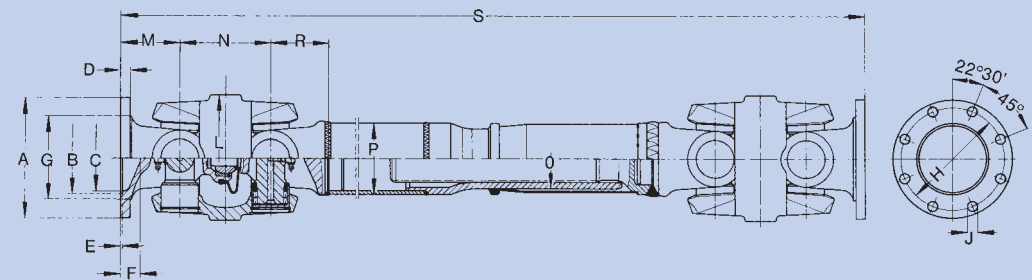

On both sides with centered double joint, connected with each other by length extension

Please indicate compressed length „S“, extension and max. r.p.m. when ordering!

Cardan drive-shafts, double / single joint with length extension

Order number		0.313.114	0.358.114	0.320.114
Md _{max}	Nm	4000	7400	15200
Angle of deflection β	°	35/40	35/42	30/42
A	mm	120	150	180
B ^{H7}	mm	75	90	110
C	mm	70	82	104
D	mm	9	12	14
E ^{+0.5}	mm	2,5	3	3,6
F	mm	27,5	25	22
G	mm	80,5	104	118
H ^{+0.1}	mm	101,5	130	155,5
J ^{B12}	mm	10	12	16
K	mm	72	90	96
L	mm	138	158	180
M	mm	60	75	86
N	mm	105	115	140
O	mm	62	75	93
P ₁	mm	70x4	90x4	110x6
P ₂	mm	80x4	100x4	120x6
P ₃	mm	100x4	120x5	–
R	mm	62	75	88
S _{min}	mm	670	810	822
X	mm	130	110	110
Weight	kg	–	39,37	–
Spline dim DIN 5480	mm	50x2,0x24	60x2,5x22	75x2,5x28
Number of flange holes		8	8	10

Please indicate compressed length „S“, extension and max. r.p.m. when ordering!

Cardan drive-shafts, double joint with length extension

Order number		0.313.115	0.358.115	0.320.115
Md _{max}	Nm	4000	7400	15200
Angle of deflection β	°	40	42	42
A	mm	120	150	180
B ^{H7}	mm	75	90	110
C approx.	mm	70	84	104
D	mm	9	12	14
E ^{+0.5}	mm	2,5	3	3,6
F	mm	27,5	25	22
G	mm	80,5	104	118
H ^{+0.1}	mm	101,5	130	155,5
J ^{B12}	mm	10	12	16
L	mm	138	158	180
M	mm	60	75	86
N	mm	105	115	140
O	mm	62	75	93
P ₁	mm	70x4	90x4	110x6
P ₂	mm	80x4	100x4	120x6
P ₃	mm	100x4	120x5	–
R	mm	62	75	88
S _{min}	mm	757	924	980
X	mm	130	110	110
Weight	kg	–	48,18	–
Spline dim DIN 5480	mm	50x2,0x24	60x2,5x22	75x2,5x28
Number of flange holes		8	8	10

Md_{max} = Maximum permitted torque. See technical appendage

β = Maximum angle of deflection (per joint)

S_{min} = Minimum compressed length for preferred extension

X = Preferred extension (larger extensions available up to approx. 9 x spline o. D.)

P₁ = Tube diameter. Dimensions in bold type for normal applications.

Alternative dimensions are for long shafts at high speeds, see technical annex domain speed

P₂ = Alternative tube

P₃ = Alternative tube

By **0.313** only external lubrication possible

Cross Units

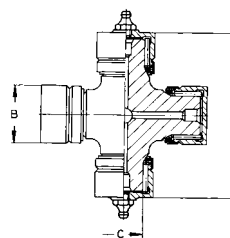
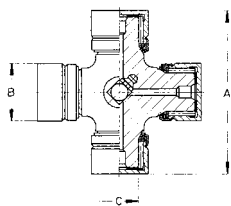

Needle bearing version

		Version suitable for external lubrication Needle bearing
Order number		0.113.012
A	mm	106
B	mm	38
C	mm	26,28
Snap rings included	mm	J 38 x 1,5
Weight	kg	1,33

Roller bearing version

		Standard version Roller bearing	Version suitable for external lubrication Roller bearing
Order number		0.158.015 0.120.015	0.113.016
A	mm	126 152	106
B	mm	48 57	38
C	mm	33,15 40,9	25,7
Snap rings included	mm	J 48 x 1,75 J 57 x 2	J 38 x 1,5
Weight	kg	2,28 4,21	1,34
used for		0.358 0.320	

double-joint version for Steering Axles

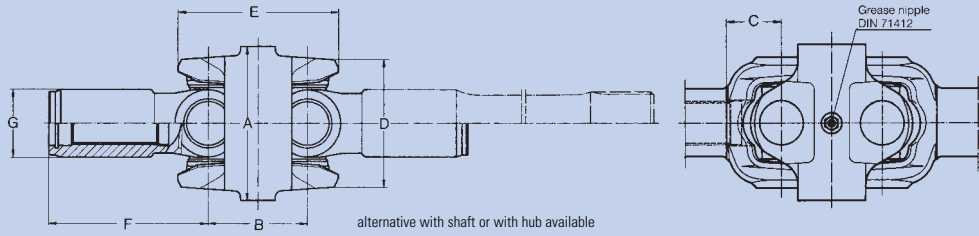

All series are available with sun pinion-forkshaft.

Cardan Drive-Shafts, double-joint version for Steering Axles, Needle bearing version

Order number		0.403.300	0.408.500	0.409.500	0.411.500	0.412.500
Md _{max}	Nm	1650	2210	2860	4160	6110
Angle of deflection β	°	55	52	50	50	50
A	mm	87	96	111	126	138
B	mm	57	63	70	81	89
C	mm	33	33	41,5	39	48
D	mm	68	78	90	105	114
E	mm	89	101	111,5	128	144
F	mm	–	89	100	113	143
G	mm	–	46	46	56	60

All series are available with sun pinion-forkshaft.

Cardan Drive-Shafts, double-joint version for Steering Axles, Roller bearing version

Order number		0.409.500	0.411.500
Md _{max}	Nm	3120	4680
Angle of deflection β	°	52	52
A	mm	111	126
B	mm	70	81
C	mm	41,5	41
D	mm	90	105
E	mm	111,5	131
F	mm	100	112
G	mm	46	56

Other Dimensions and larger angles of deflection on request.
Angle of deflection up 55° on request.

Md_{max} = Maximum operating torque referring to center piece including spider-set by 0° position
β = Maximum angle of deflection, when ordering, please indicate this together with required shaft dimension.
For application principles, Center offset and max. axial float see technical annex.

0.400

0.400

Cross Units

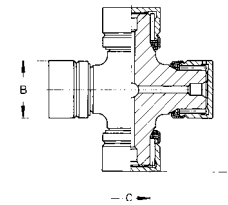

Needle bearing version

Standard version
Needle bearing

Order number		0.403	0.412	0.408.011.014	0.408.011.015	0.110.011	0.112.011	0.113.011
A	mm	62,6	105,6	70,15	70,7	83	97	106
B	mm	23,8	40	27	28,5	30	35	38
C	mm	16	27,9	18,27	19,87	19,9	23,04	26,28
Snap ring included	mm	J 24 x 1,2	J 40 x 1,75	J 27 x 1,5	J 29 x 1,2	J 30 x 1,2	J 35 x 1,5	J 38 x 1,5
Weight	kg	–	–	0,45	0,51	0,66	0,98	1,30
used for		0.403	0.412	0.408	0.408	0.409	0.411	0.412

Roller bearing version

Standard version
Roller bearing

Order number		0.110.017	0.112.017
A	mm	83	97
B	mm	30	35
C	mm	20,02	24,08
Snap ring included	mm	J 30 x 1,2	J 35 x 1,5
Weight	kg	0,66	0,94
used for		0.409	0.411

double-joint version for Steering Axles

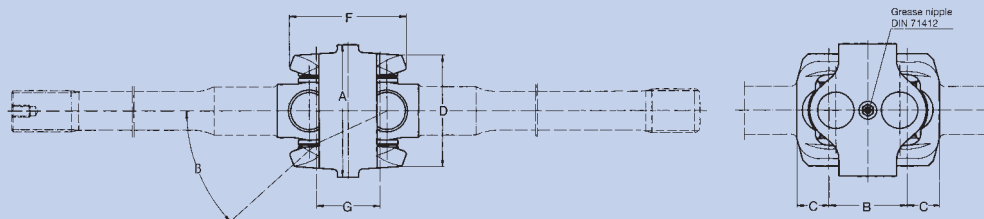

Cardan Drive-Shafts, double-joint version for Steering Axles, Needle bearing version

Order number		0.509.3	0.511.3	0.512.3	0.513.3	0.515.3	0.516.3	0.518.3
Md _{max}	Nm	2860	5200	7150	8450	10920	13000	16900
Angle of deflection β	°	42 / 47	42 / 47	42 / 47	42 / 47	42 / 47	42 / 47	42 / 47
A	mm	105	128	138	146	160	174	195
B	mm	63 / 66	73 / 77	81 / 86	86 / 90	94 / 100	103 / 108	110 / 116
C	mm	26	31	33	37	39	43	45
D	mm	86	104	115	118	134	145	162
F	mm	94 / 99	108 / 119	121 / 125	130 / 134	140 / 146	150 / 156	158 / 164
G	mm	53 / 56	61 / 65	66 / 71	71 / 75	78 / 84	83 / 88	90 / 96

Cardan Drive-Shafts, double-joint version for Steering Axles, Roller bearing version

Order number		0.510.3	0.511.3	0.512.3
Md _{max}	Nm	4160	5200	7150
Angle of deflection β	°	* / 50	42 / 47	42 / 47
A	mm	115	128	138
B	mm	* / 77	73 / 77	84 / 89
C	mm	30	31	33
D	mm	95	104	116
F	mm	* / 109	108 / 119	125
G	mm	* / 63	61 / 65	69 / 74

Md_{max} = Maximum operating torque referring to center piece including spider-set by 0° position
 β = Maximum angle of deflection, when ordering, please indicate this together with required shaft dimension.
 For application principles, Center offset and max. axial float see technical annex.
 * = on request

Cross Units

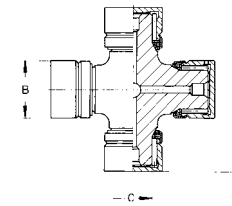

Needle bearing version

Standard version
Needle bearing

Order number		0.509.021	0.511.021	0.512.021	0.513.021	0.515.021	0.516.021	0.518.021
A	mm	79	96	107	110	125	134	152
B	mm	30	35	38	42	45	50	50
C	mm	19,9	23,04	26,28	28,6	31,8	33,4	33,4
Snap rings included	mm	J 30 x 1,2	J 35 x 1,5	J 38 x 1,5	J 42 x 1,75	J 45 x 1,75	J 50 x 2	J 50 x 2
Weight	kg	0,60	0,95	1,32	1,70	2,20	3,00	3,40
used for		0.509	0.511	0.512	0.513	0.515	0.516	0.518

Roller bearing version

Standard version
Roller bearing

Order number		0.510.021	0.511.021
A	mm	87	96
B	mm	35	35
C	mm	24,8	24,8
Snap rings included	mm	J 35 x 1,5	J 35 x 1,5
Weight	kg	0,83	0,98
used for		0.510	0.511

Needle bearing version, with length compensation

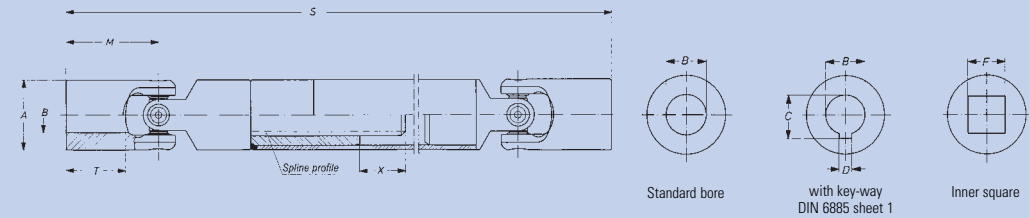
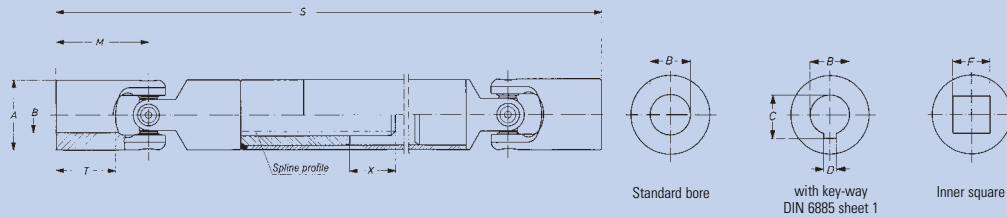

Please indicate compressed length „S“, extension and required type of flange when ordering!

Order number	Precision Cardan Shafts, Standard bore							Precision Cardan Shafts, Bore with key-way DIN 6885, Sheet 1		Precision Cardan Shafts, Inner square					
	0.616.100	0.620.100	0.625.100	0.632.100	0.640.100	0.650.100	0.663.100	0.616.103	0.620.103	0.625.103	0.632.103	0.640.103	0.650.103	0.663.103	
Md _{max}	Nm	6	15	20	40	80	120	250	6	15	20	40	80	120	250
Angle of deflection β	°	45	45	45	45	45	45	45	45	45	45	45	45	45	45
Weight by S ₁	kg	0,20	0,33	0,59	1,09	2,13	4,0	8,25	0,20	0,33	0,59	1,09	2,13	4,0	8,25
Weight by S ₂	kg	0,24	0,39	0,68	1,21	2,28	4,44	8,75	0,24	0,39	0,68	1,21	2,28	4,44	8,75
Weight by S ₃	kg	0,26	0,42	0,72	1,35	2,57	4,98	9,70	0,26	0,42	0,72	1,35	2,57	4,98	9,70
A	mm	16	20	25	32	40	50	63	16	20	25	32	40	50	63
*B ^{H7}	mm	10	12	16	20	25	32	40	10	12	16	20	25	32	40
*C ^{H9}	mm	–	–	–	–	–	–	–	11,4	13,8	–	–	–	–	–
*D ^{H9}	mm	–	–	–	–	–	–	–	3	4	–	–	–	–	–
*F ^{H9}	mm	–	–	–	–	–	–	–	–	–	–	–	–	–	–
M	mm	26	31	37	43	54	66	83	26	31	37	43	54	66	83
S ₁ + X ₁	mm	165 + 15	174 + 20	198 + 25	234 + 30	301 + 40	372 + 50	475 + 70	165 + 15	174 + 20	198 + 25	234 + 30	301 + 40	372 + 50	475 + 70
S ₂ + X ₂	mm	185 + 30	194 + 40	228 + 55	264 + 60	321 + 60	422 + 100	505 + 100	185 + 30	194 + 40	228 + 55	264 + 60	321 + 60	422 + 100	505 + 100
S ₃ + X ₃	mm	210 + 60	224 + 70	248 + 75	294 + 90	371 + 110	472 + 150	585 + 180	210 + 60	224 + 70	248 + 75	294 + 90	371 + 110	472 + 150	585 + 180
T	mm	15	18	22	25	32	40	50	15	18	22	25	32	40	50
Spline profile	mm	6x7,5x10,2	6x11x14	6x11x14	6x16x20	6x21x25	6x28x32	6x36x42	6x7,5x10,2	6x11x14	6x11x14	6x16x20	6x21x25	6x28x32	6x36x42

These drive shafts are also available with rapid-change coupling.
 * = Customized bores, key-way and inner square dimensions possible
 Md_{max} = Max. permissible torque
 β = Max. angle of deflection per joint
 S₁
 S₂ = preferred lengths, compressed
 S₃
 X₁ = Maximum extension for S₁
 X₂ = Maximum extension for S₂
 X₃ = Maximum extension for S₃
 For application criteria and calculations refer to technical annex

Order number	Precision Cardan Shafts, Bore with key-way DIN 6885, Sheet 1					Precision Cardan Shafts, Inner square							
	0.625.103	0.632.103	0.640.103	0.650.103	0.663.103	0.616.104	0.620.104	0.625.104	0.632.104	0.640.104	0.650.104	0.663.104	
Md _{max}	Nm	20	40	80	120	250	6	15	20	40	80	120	250
Angle of deflection β	°	45	45	45	45	45	45	45	45	45	45	45	45
Weight by S ₁	kg	0,59	1,09	2,13	4,0	8,25	0,20	0,33	0,59	1,09	2,13	4,0	8,25
Weight by S ₂	kg	0,68	1,21	2,28	4,44	8,75	0,24	0,39	0,68	1,21	2,28	4,44	8,75
Weight by S ₃	kg	0,72	1,35	2,57	4,98	9,70	0,26	0,42	0,72	1,35	2,57	4,98	9,70
A	mm	25	32	40	50	63	16	20	25	32	40	50	63
*B ^{H7}	mm	16	20	25	32	40	–	–	–	–	–	–	–
*C ^{H9}	mm	18,3	22,8	28,3	35,3	43,3	–	–	–	–	–	–	–
*D ^{H9}	mm	5	6	8	10	12	–	–	–	–	–	–	–
*F ^{H9}	mm	–	–	–	–	–	8	10	12	16	20	25	32
M	mm	37	43	54	66	83	26	31	37	43	54	66	83
S ₁ + X ₁	mm	198 + 25	234 + 30	301 + 40	372 + 50	475 + 70	165 + 15	174 + 20	198 + 25	234 + 30	301 + 40	372 + 50	475 + 70
S ₂ + X ₂	mm	228 + 55	264 + 60	321 + 60	422 + 100	505 + 100	185 + 30	194 + 40	228 + 55	264 + 60	321 + 60	422 + 100	505 + 100
S ₃ + X ₃	mm	248 + 75	294 + 90	371 + 110	472 + 150	585 + 180	210 + 60	224 + 70	248 + 75	294 + 90	371 + 110	472 + 150	585 + 180
T	mm	22	25	32	40	50	15	18	22	25	32	40	50
Spline profile	mm	6x11x14	6x16x20	6x21x25	6x28x32	6x36x42	6x7,5x10,2	6x11x14	6x11x14	6x16x20	6x21x25	6x28x32	6x36x42

double, DIN 808, Needle bearing version

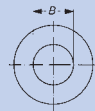
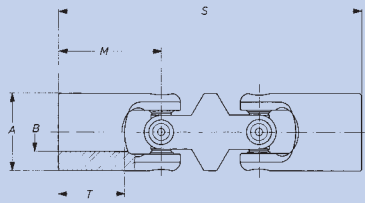

Standard bore

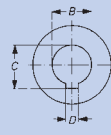

with key-way
DIN 6885 sheet 1

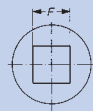

Inner square

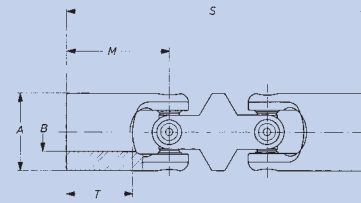

Standard bore

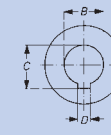

with key-way
DIN 6885 sheet 1

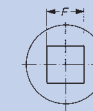

Inner square

Precision Cardan Shafts, Standard bore

Precision Cardan Shafts, Bore with key-way DIN 6885, Sheet 1

Precision Cardan Shafts, Inner square

Order number		0.616.300	0.620.300	0.625.300	0.632.300	0.640.300	0.650.300	0.663.300	0.616.303	0.620.303
Md _{max}	Nm	6	15	20	40	80	120	250	6	15
Angle of deflection β	°	45	45	45	45	45	45	45	45	45
Weight	kg	0,08	0,14	0,24	0,50	0,95	1,71	3,06	0,08	0,14
A	mm	16	20	25	32	40	50	63	16	20
*B ^{H7}	mm	10	12	16	20	25	32	40	10	12
*C ^{H8}	mm	–	–	–	–	–	–	–	11,4	13,8
*D ^{H9}	mm	–	–	–	–	–	–	–	3	4
*E ^{H8}	mm	–	–	–	–	–	–	–	–	–
M	mm	26	31	37	43	54	66	83	26	31
S	mm	74	88	104	124	156	188	238	74	88
T	mm	15	18	22	25	32	40	50	15	18

0.625.303	0.632.303	0.640.303	0.650.303	0.663.303	0.616.304	0.620.304	0.625.304	0.632.304	0.640.304	0.650.304	0.663.304
20	40	80	120	250	6	15	20	40	80	120	250
45	45	45	45	45	45	45	45	45	45	45	45
0,24	0,50	0,95	1,71	3,06	0,08	0,14	0,24	0,50	0,95	1,71	3,06
25	32	40	50	63	16	20	25	32	40	50	63
16	20	25	32	40	–	–	–	–	–	–	–
18,3	22,8	28,3	35,3	43,3	–	–	–	–	–	–	–
5	6	8	10	12	–	–	–	–	–	–	–
–	–	–	–	–	8	10	12	16	20	25	32
37	43	54	66	83	26	31	37	43	54	66	83
104	124	156	188	238	74	88	104	124	156	188	238
22	25	32	40	50	15	18	22	25	32	40	50

* = Customized bores, key-way and inner square dimensions possible
 Md_{max} = Max. permissible torque
 β = Max. angle of deflection per joint
 For application criteria and calculations refer to technical annex

0.600

0.600

single, DIN 808, Needle bearing version

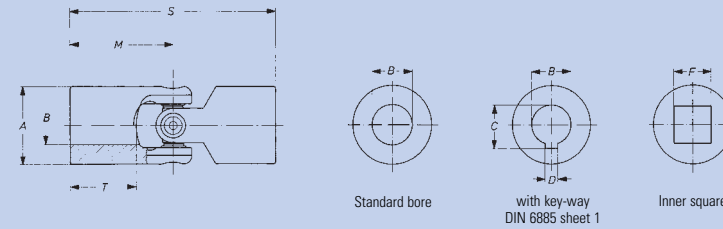
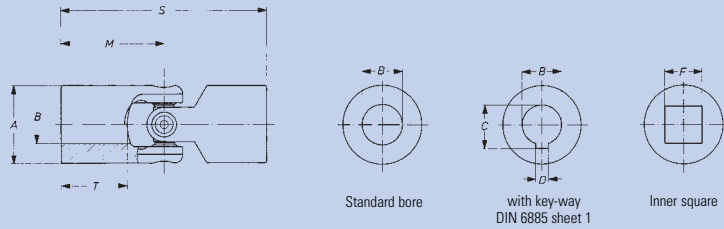

Precision Cardan Shafts, Standard bore

Precision Cardan Shafts, Bore with key-way DIN 6885, Sheet 1

Precision Cardan Shafts, Inner square

Order number		Precision Cardan Shafts, Standard bore							Precision Cardan Shafts, Bore with key-way DIN 6885, Sheet 1	
		0.616.400	0.620.400	0.625.400	0.632.400	0.640.400	0.650.400	0.663.400	0.616.403	0.620.403
Md _{max}	Nm	6	15	20	40	80	120	250	6	15
Angle of deflection β	°	45	45	45	45	45	45	45	45	45
Weight	kg	0,05	0,10	0,16	0,31	0,61	1,15	2,17	0,05	0,10
A	mm	16	20	25	32	40	50	63	16	20
*B ^{H7}	mm	10	12	16	20	25	32	40	10	12
*C ^{+0,2}	mm	–	–	–	–	–	–	–	11,4	13,8
*D ^{P9}	mm	–	–	–	–	–	–	–	3	4
*E ^{H9}	mm	–	–	–	–	–	–	–	–	–
M	mm	26	31	37	43	54	66	83	26	31
S	mm	52	62	74	86	108	132	166	52	62
T	mm	15	18	22	25	32	40	50	15	18

Order number		Precision Cardan Shafts, Bore with key-way DIN 6885, Sheet 1					Precision Cardan Shafts, Inner square						
		0.625.403	0.632.403	0.640.403	0.650.403	0.663.403	0.616.404	0.620.404	0.625.404	0.632.404	0.640.404	0.650.404	0.663.404
Md _{max}	Nm	20	40	80	120	250	6	15	20	40	80	120	250
Angle of deflection β	°	45	45	45	45	45	45	45	45	45	45	45	45
Weight	kg	0,16	0,31	0,61	1,15	2,17	0,05	0,10	0,16	0,31	0,61	1,15	2,17
A	mm	25	32	40	50	63	16	20	25	32	40	50	63
*B ^{H7}	mm	16	20	25	32	40	–	–	–	–	–	–	–
*C ^{+0,2}	mm	18,3	22,8	28,3	35,3	43,3	–	–	–	–	–	–	–
*D ^{P9}	mm	5	6	8	10	12	–	–	–	–	–	–	–
*E ^{H9}	mm	–	–	–	–	–	8	10	12	16	20	25	32
M	mm	37	43	54	66	83	26	31	37	43	54	66	83
S	mm	74	86	108	132	166	52	62	74	86	108	132	166
T	mm	22	25	32	40	50	15	18	22	25	32	40	50

* = Customized bores, key-way and inner square dimensions possible
 Md_{max} = Max. permissible torque
 β = Max. angle of deflection per joint
 For application criteria and calculations refer to technical annex

single, Short Version, DIN 808, Needle bearing version

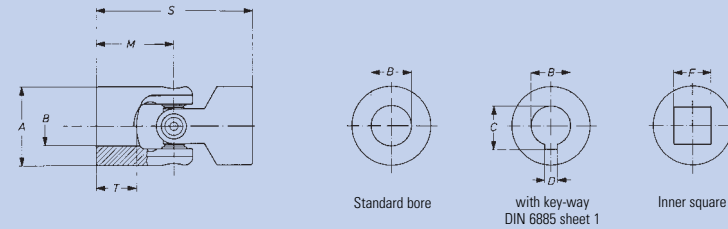
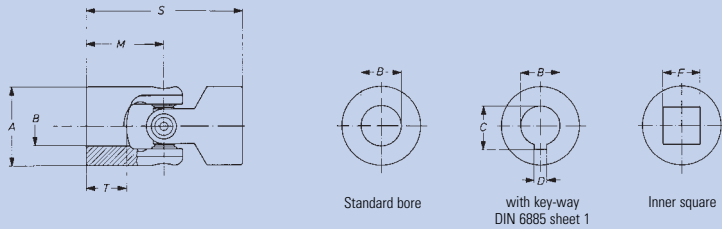

Precision Cardan Shafts, Standard bore

Precision Cardan Shafts, Bore with key-way DIN 6885, Sheet 1

Precision Cardan Shafts, Inner square

Order number	Precision Cardan Shafts, Standard bore							Precision Cardan Shafts, Bore with key-way DIN 6885, Sheet 1		
	0.616.410	0.620.410	0.625.410	0.632.410	0.640.410	0.650.410	0.663.410	0.616.413	0.620.413	
Md _{max}	Nm	6	15	20	40	80	120	250	6	15
Angle of deflection β	°	45	45	45	45	45	45	45	45	45
Weight	kg	0,03	0,07	0,10	0,22	0,42	0,80	1,88	0,03	0,07
A	mm	16	20	25	32	40	50	63	16	20
*B ^{H7}	mm	8	10	12	16	20	25	32	8	10
*C ^{+0,2}	mm	–	–	–	–	–	–	–	9	11,4
*D ^{P9}	mm	–	–	–	–	–	–	–	2	3
*E ^{H9}	mm	–	–	–	–	–	–	–	–	–
M	mm	20	24	28	34	41	52,5	65	20	24
S	mm	40	48	56	68	82	105	130	40	48
T	mm	11	13	15	18**	20**	27**	36	11	13

Precision Cardan Shafts, Bore with key-way DIN 6885, Sheet 1					Precision Cardan Shafts, Inner square						
0.625.413	0.632.413	0.640.413	0.650.413	0.663.413	0.616.414	0.620.414	0.625.414	0.632.414	0.640.414	0.650.414	0.663.414
20	40	80	120	250	6	15	20	40	80	120	250
45	45	45	45	45	45	45	45	45	45	45	45
0,10	0,22	0,42	0,80	1,88	0,03	0,07	0,10	0,22	0,42	0,80	1,88
25	32	40	50	63	16	20	25	32	40	50	63
12	16	20	25	32	–	–	–	–	–	–	–
13,8	18,3	22,8	28,3	35,3	–	–	–	–	–	–	–
4	5	6	8	10	–	–	–	–	–	–	–
–	–	–	–	–	6	8	10	14	19	24	30
28	34	41	52,5	65	20	24	28	34	41	52,5	65
56	68	82	105	130	40	48	56	68	82	105	130
15	18**	20**	27**	36	11	13	15	18**	20**	27**	36

* = Customized bores, key-way and inner square dimensions possible
 ** = Bore depth smaller than DIN 808
 Md_{max} = Max. permissible torque
 β = Max. angle of deflection per joint
 For application criteria and calculations refer to technical annex

single, with rapid-change coupling, DIN 808, Needle bearing version

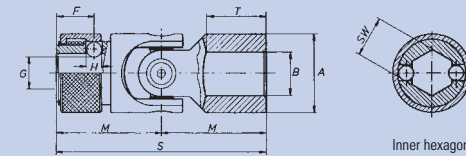
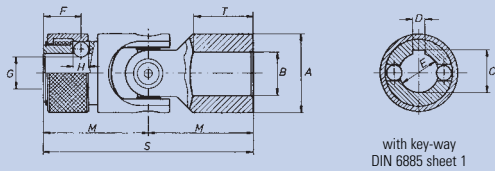

Precision Cardan Joints, with rapid-change coupling, Bore with key-way DIN 6885, Sheet 1

Order number		0.616.423	0.620.423	0.625.423	0.632.423	0.640.423	0.650.423	0.663.423
Md _{max}	Nm	6	15	20	40	80	120	250
Angle of deflection β	°	45	45	45	45	45	45	45
Weight	kg	0,05	0,10	0,16	0,31	0,61	1,15	1,90
A	mm	16	20	25	32	40	50	63
*B ^{H7}	mm	8	10	14	16	20	25	30
*C ^{+0,2}	mm	9	11	15,3	17,3	21,7	26,7	31,7
*D ^{H8}	mm	2	3	5	5	6	8	8
*E ^{H7}	mm	8	10	14	16	20	25	30
F ^{H8}	mm	9,5	11,5	13,5	14	19	20,5	25
G	mm	7	8,7	13	14,8	18	23	28
H	mm	3,5	4	4	6,35	8	10	10
M	mm	26	31	37	43	54	66	83
S	mm	52	62	74	86	108	132	166
*SW	mm	–	–	–	–	–	–	–
T	mm	15	18	22	25	32	40	50

Precision Cardan Joints, with rapid-change coupling, Inner hexagon

	0.616.426	0.620.426	0.625.426	0.625.427	0.632.426	0.640.426	0.650.426	0.663.426	0.663.427
Md _{max}	6	15	20	20	40	80	120	250	250
Angle of deflection β	45	45	45	45	45	45	45	45	45
Weight	0,05	0,10	0,16	0,16	0,31	0,61	1,15	1,90	1,90
A	16	20	25	25	32	40	50	63	63
*B ^{H7}	8	10	14	14	16	20	25	30	30
*C ^{+0,2}	–	–	–	–	–	–	–	–	–
*D ^{H8}	–	–	–	–	–	–	–	–	–
*E ^{H7}	–	–	–	–	–	–	–	–	–
F ^{H8}	9,5	11,5	13,5	13,5	14	19	20,5	25	25
G	6,3	8	13	10,5	14,8	18	23	28	33
H	3,5	4	4	4	6,35	8	10	10	10
M	26	31	37	37	43	54	66	83	83
S	52	62	74	74	86	108	132	166	166
*SW	7,2	9,06	14,04	11,15	16	20	25	30	35
T	15	18	22	22	25	32	40	50	50

* = Customized bores, key-way and inner hexagon dimensions possible
 Md_{max} = Max. permissible torque
 β = Max. angle of deflection per joint
 For application criteria and calculations refer to technical annex

■ TIP ■



There are application examples in which frequent removal of the universal joint shaft or the joint from the drive or the output shaft is required.

In this case the use of a rapid-change coupling allows to change the shaft within very short time. This is done manually without any tools.

Torque transmission is ensured via a hexagonal profile or a feather key. Two steel balls which grip into a circular groove at the shaft connection provide axial locking of the shaft.

Needle bearing version, with length compensation

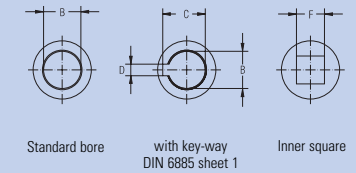
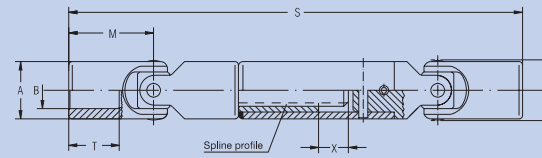
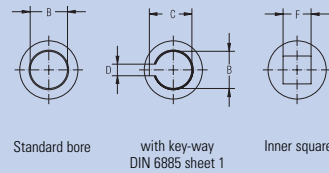
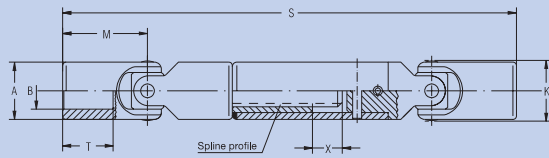

Please indicate compressed length „S“, extension and required type of flange when ordering!

Order number	Cross Cardan Shafts, Standard bore							Cross Cardan Shafts, Bore with key-way DIN 6885, Sheet 1		
	0.716.100	0.720.100	0.725.100	0.732.100	0.740.100	0.750.100	0.763.100	0.716.103	0.720.103	
Md _{max}	Nm	8	20	30	60	160	290	450	8	20
Angle of deflection β	°	45	45	45	45	45	45	45	45	45
Weight by S ₁	kg	0,20	0,33	0,59	1,09	2,13	4,0	8,24	0,20	0,33
Weight by S ₂	kg	0,24	0,39	0,68	1,21	2,28	4,44	8,74	0,24	0,39
Weight by S ₃	kg	0,26	0,42	0,72	1,35	2,57	4,98	9,72	0,26	0,42
A	mm	16	20	25	32	40	50	63	16	20
*B ^{H7}	mm	10	12	16	20	25	32	40	10	12
*C ^{H9}	mm	–	–	–	–	–	–	–	11,4	13,8
*D ^{H9}	mm	–	–	–	–	–	–	–	3	4
*E ^{H9}	mm	–	–	–	–	–	–	–	–	–
K	mm	17,5	21,5	26,5	33,5	42	52,5	65	17,5	21,5
M	mm	26	31	37	43	54	66	83	26	31
S ₁ + X ₁	mm	165 + 15	174 + 20	198 + 25	234 + 30	301 + 40	372 + 50	475 + 70	165 + 15	174 + 20
S ₂ + X ₂	mm	185 + 30	194 + 40	228 + 55	264 + 60	321 + 60	422 + 100	505 + 100	185 + 30	194 + 40
S ₃ + X ₃	mm	210 + 60	224 + 70	248 + 75	294 + 90	371 + 110	472 + 150	585 + 180	210 + 60	224 + 70
T	mm	15	18	22	25	32	40	50	15	18
Spline profile	mm	6x7,5x10,2	6x11x14	6x11x14	6x16x20	6x21x25	6x28x32	6x36x42	6x7,5x10,2	6x11x14

These drive shafts are also available with rapid-change coupling.
 * = Customized bores, key-ways and inner square dimensions possible
 Md_{max} = Max. permissible torque
 β = Max. angle of deflection per joint
 S₁ = preferred lengths, compressed
 S₂ = preferred lengths, compressed
 S₃ = preferred lengths, compressed
 X₁ = Maximum extension for S₁
 X₂ = Maximum extension for S₂
 X₃ = Maximum extension for S₃
 For application criteria and calculations refer to technical annex

Cross Cardan Shafts, Bore with key-way DIN 6885, Sheet 1					Cross Cardan Shafts, Inner square						
0.725.103	0.732.103	0.740.103	0.750.103	0.763.103	0.716.104	0.720.104	0.725.104	0.732.104	0.740.104	0.750.104	0.763.104
30	60	160	290	450	8	20	30	60	160	290	450
45	45	45	45	45	45	45	45	45	45	45	45
0,59	1,09	2,13	4,0	8,24	0,20	0,33	0,59	1,09	2,13	4,0	8,24
0,68	1,21	2,28	4,44	8,74	0,24	0,39	0,68	1,21	2,28	4,44	8,74
0,72	1,35	2,57	4,98	9,72	0,26	0,42	0,72	1,35	2,57	4,98	9,72
25	32	40	50	63	16	20	25	32	40	50	63
16	20	25	32	40	–	–	–	–	–	–	–
18,3	22,8	28,3	35,3	43,3	–	–	–	–	–	–	–
5	6	8	10	12	–	–	–	–	–	–	–
–	–	–	–	–	8	10	12	16	20	25	32
26,5	33,5	42	52,5	65	17,5	21,5	26,5	33,5	42	52,5	65
37	43	54	66	83	26	31	37	43	54	66	83
198 + 25	234 + 30	301 + 40	372 + 50	475 + 70	165 + 15	174 + 20	198 + 25	234 + 30	301 + 40	372 + 50	475 + 70
228 + 55	264 + 60	321 + 60	422 + 100	505 + 100	185 + 30	194 + 40	228 + 55	264 + 60	321 + 60	422 + 100	505 + 100
248 + 75	294 + 90	371 + 110	472 + 150	585 + 180	210 + 60	224 + 70	248 + 75	294 + 90	371 + 110	472 + 150	585 + 180
22	25	32	40	50	15	18	22	25	32	40	50
6x11x14	6x16x20	6x21x25	6x28x32	6x36x42	6x7,5x10,2	6x11x14	6x11x14	6x16x20	6x21x25	6x28x32	6x36x42

double, DIN 808

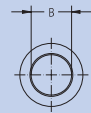
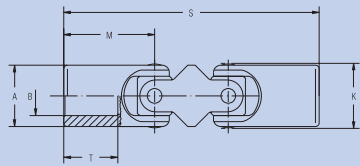

Standard bore

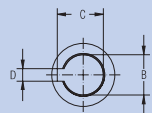

with key-way
DIN 6885 sheet 1

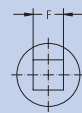

Inner square

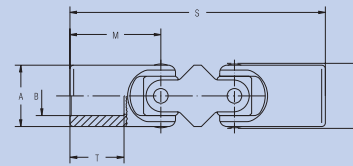

Standard bore

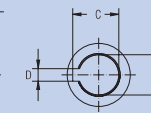

with key-way
DIN 6885 sheet 1

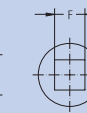

Inner square

Cross Joints, double, Standard bore

Cross Joints, double, Bore with key-way DIN 6885, Sheet 1

Cross Joints, double, Inner square

Order number	0.713.300	0.716.300	0.720.300	0.725.300	0.732.300	0.740.300	0.750.300	0.763.300	0.713.303	0.716.303
Md _{max} Nm	6	8	20	30	60	160	290	450	6	8
Angle of deflection β °	45	45	45	45	45	45	45	45	45	45
Weight kg	0,04	0,08	0,14	0,24	0,50	0,95	1,71	3,51	0,04	0,08
A mm	13	16	20	25	32	40	50	63	13	16
*B ^{H7} mm	8	10	12	16	20	25	32	40	8	10
*C ^{+0,2} mm	–	–	–	–	–	–	–	–	9	11,4
*D ^{F9} mm	–	–	–	–	–	–	–	–	2	3
*E ^{H9} mm	–	–	–	–	–	–	–	–	–	–
K mm	14	17,5	21,5	26,5	33,5	42	52,5	65	14	17,5
M mm	21	26	31	37	43	54	66	83	21	26
S mm	60	74	88	104	124	156	188	238	60	74
T mm	12	15	18	22	25	32	40	50	12	15

0.720.303	0.725.303	0.732.303	0.740.303	0.750.303	0.763.303	0.713.304	0.716.304	0.720.304	0.725.304	0.732.304	0.740.304	0.750.304	0.763.304
20	30	60	160	290	450	6	8	20	30	60	160	290	450
45	45	45	45	45	45	45	45	45	45	45	45	45	45
0,14	0,24	0,50	0,95	1,71	3,51	0,04	0,08	0,14	0,24	0,50	0,95	1,71	3,51
20	25	32	40	50	63	13	16	20	25	32	40	50	63
12	16	20	25	32	40	–	–	–	–	–	–	–	–
13,8	18,3	22,8	28,3	35,3	43,3	–	–	–	–	–	–	–	–
4	5	6	8	10	12	–	–	–	–	–	–	–	–
–	–	–	–	–	–	6	8	10	12	16	20	25	32
21,5	26,5	33,5	42	52,5	65	14	17,5	21,5	26,5	33,5	42	52,5	65
31	37	43	54	66	83	21	26	31	37	43	54	66	83
88	104	124	156	188	238	60	74	88	104	124	156	188	238
18	22	25	32	40	50	12	15	18	22	25	32	40	50

* = Customized bores, key-ways and inner square dimensions possible
 Md_{max} = Max. permissible torque
 β = Max. angle of deflection per joint
 For application criteria and calculations refer to technical annex

single, DIN 808

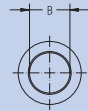
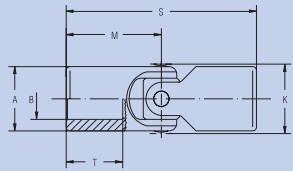

Standard bore

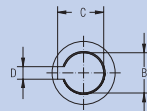

with key-way
DIN 6885 sheet 1

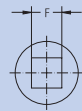

Inner square

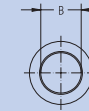
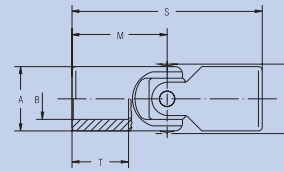

Standard bore

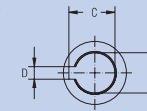

with key-way
DIN 6885 sheet 1

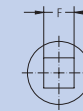

Inner square

Cross Joints, single, Standard bore

Cross Joints, single, Bore with key-way DIN 6885, Sheet 1

Cross Joints, single, Inner square

Order number		0.713.400	0.716.400	0.720.400	0.725.400	0.732.400	0.740.400	0.750.400	0.763.400	0.713.403	0.716.403
Md _{max}	Nm	6	8	20	30	60	160	290	450	6	8
Angle of deflection β	°	45	45	45	45	45	45	45	45	45	45
Weight	kg	0,03	0,05	0,10	0,16	0,31	0,61	1,15	2,38	0,03	0,05
A	mm	13	16	20	25	32	40	50	63	13	16
*B ^{H7}	mm	8	10	12	16	20	25	32	40	8	10
*C ^{+0,2}	mm	–	–	–	–	–	–	–	–	9	11,4
*D ^{F9}	mm	–	–	–	–	–	–	–	–	2	3
*E ^{H9}	mm	–	–	–	–	–	–	–	–	–	–
K	mm	14	17,5	21,5	26,5	33,5	42	52,5	65	14	17,5
M	mm	21	26	31	37	43	54	66	83	21	26
S	mm	42	52	62	74	86	108	132	166	42	52
T	mm	12	15	18	22	25	32	40	50	12	15

	0.720.403	0.725.403	0.732.403	0.740.403	0.750.403	0.763.403	0.713.404	0.716.404	0.720.404	0.725.404	0.732.404	0.740.404	0.750.404	0.763.404
	20	30	60	160	290	450	6	8	20	30	60	160	290	450
	45	45	45	45	45	45	45	45	45	45	45	45	45	45
	0,10	0,16	0,31	0,61	1,15	2,38	0,03	0,05	0,10	0,16	0,31	0,61	1,15	2,38
	20	25	32	40	50	63	13	16	20	25	32	40	50	63
	12	16	20	25	32	40	–	–	–	–	–	–	–	–
	13,8	18,3	22,8	28,3	35,3	43,3	–	–	–	–	–	–	–	–
	4	5	6	8	10	12	–	–	–	–	–	–	–	–
	–	–	–	–	–	–	6	8	10	12	16	20	25	32
	21,5	26,5	33,5	42	52,5	65	14	17,5	21,5	26,5	33,5	42	52,5	65
	31	37	43	54	66	83	21	26	31	37	43	54	66	83
	62	74	86	108	132	166	42	52	62	74	86	108	132	166
	18	22	25	32	40	50	12	15	18	22	25	32	40	50

* = Customized bores, key-ways and inner square dimensions possible
 Md_{max} = Max. permissible torque
 β = Max. angle of deflection per joint
 For application criteria and calculations refer to technical annex

single, Short version, DIN 808

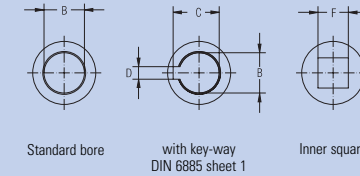
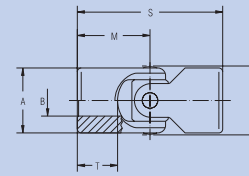
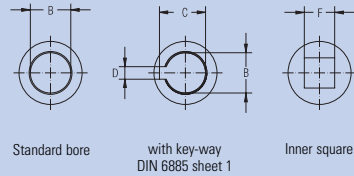
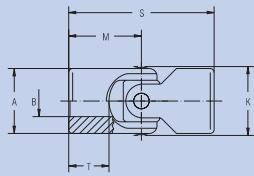

Cross Joints, single, Short version, Standard bore | Cross Joints, single, Short vers., Bore with key-way DIN 6885, Sheet 1 | Cross Joints, single, Short version, Inner square

Order number	0.716.410	0.716.411	0.720.410	0.725.410	0.732.410	0.740.410	0.750.410	0.763.410	0.716.413	0.720.413
Md _{max} Nm	8	8	20	30	60	160	290	450	8	20
Angle of deflection β °	45	45	45	45	45	45	45	45	45	45
Weight kg	0,02	0,03	0,07	0,10	0,22	0,42	0,80	2,12	0,03	0,07
A mm	16	16	20	25	32	40	50	63	16	20
*B ^{H7} mm	6	8	10	12	16	20	25	32	8	10
*C ^{+0,2} mm	–	–	–	–	–	–	–	–	9	11,4
*D ^{F9} mm	–	–	–	–	–	–	–	–	2	3
*F ^{H9} mm	–	–	–	–	–	–	–	–	–	–
K mm	17,5	17,5	21,5	26,5	33,5	42	52,5	65	17,5	21,5
M mm	17	20	24	28	34	41	52,5	65	20	24
S mm	34	40	48	56	68	82	105	130	40	48
T mm	9	11	13	15	19	21**	28**	36	11	13

0.725.413	0.732.413	0.740.413	0.750.413	0.763.413	0.716.414	0.720.414	0.725.414	0.732.414	0.740.414	0.750.414	0.763.414
30	60	160	290	450	8	20	30	60	160	290	450
45	45	45	45	45	45	45	45	45	45	45	45
0,10	0,22	0,42	0,80	2,12	0,03	0,07	0,10	0,22	0,42	0,80	2,12
25	32	40	50	63	16	20	25	32	40	50	63
12	16	20	25	32	–	–	–	–	–	–	–
13,8	18,3	22,8	28,3	35,3	–	–	–	–	–	–	–
4	5	6	8	10	–	–	–	–	–	–	–
–	–	–	–	–	6	8	10	14	19	24	30
26,5	33,5	42	52,5	65	17,5	21,5	26,5	33,5	42	52,5	65
28	34	41	52,5	65	20	24	28	34	41	52,5	65
56	68	82	105	130	40	48	56	68	82	105	130
15	19	21**	28**	36	11	13	15	19	21**	28**	36

* = Customized bores, key-ways and inner square dimensions possible
 ** = Bore depth smaller than DIN 808
 Md_{max} = Max. permissible torque
 β = Max. angle of deflection per joint
 For application criteria and calculations refer to technical annex

single, with rapid-change coupling, DIN 808

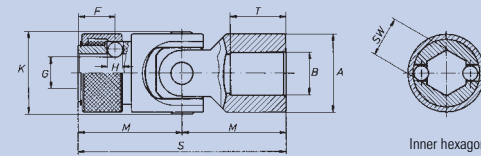
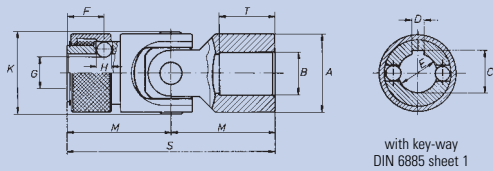

Cross Joints, with rapid-change coupling, Bore with key-way DIN 6885, Sheet 1

Order number		0.716.423	0.720.423	0.725.423	0.732.423	0.740.423	0.750.423	0.763.423
Md _{max}	Nm	8	20	30	60	160	290	450
Angle of deflection β	°	45	45	45	45	45	45	45
Weight	kg	0,05	0,10	0,16	0,31	0,61	1,15	2,08
A	mm	16	20	25	32	40	50	63
*B ^{H7}	mm	8	10	14	16	20	25	30
*C ^{H7}	mm	9	11	15,3	17,3	21,7	26,7	31,7
*D ^{H8}	mm	2	3	5	5	6	8	8
*E ^{H7}	mm	8	10	14	16	20	25	30
F	mm	9,5	11,5	13,5	14	19	20,5	25
G	mm	7	8,7	13	14,8	18	23	28
H	mm	3,5	4	4	6,35	8	10	10
K	mm	17,5	21,5	26,5	33,5	42	52,5	65
M	mm	26	31	37	43	54	66	83
S	mm	52	62	74	86	108	132	166
*SW ^{H7}	mm	–	–	–	–	–	–	–
T	mm	15	18	22	25	32	40	50

Cross Joints, with rapid-change coupling, Inner hexagon

	0.716.426	0.720.426	0.725.426	0.725.427	0.732.426	0.740.426	0.750.426	0.763.426	0.763.426
Md _{max}	8	20	30	30	60	160	290	450	450
Angle of deflection β	45	45	45	45	45	45	45	45	45
Weight	0,05	0,10	0,16	0,16	0,31	0,61	1,15	2,08	2,08
A	16	20	25	25	32	40	50	63	63
*B ^{H7}	–	–	–	–	–	–	–	–	–
*C ^{H7}	–	–	–	–	–	–	–	–	–
*D ^{H8}	–	–	–	–	–	–	–	–	–
*E ^{H7}	–	–	–	–	–	–	–	–	–
F	9,5	11,5	13,5	13,5	14	19	20,5	25	25
G	6,3	8	13	10,5	14,8	18	23	28	33
H	3,5	4	4	4	6,35	8	10	10	10
K	17,5	21,5	26,5	26,5	33,5	42	52,5	65	65
M	26	31	37	37	43	54	66	83	83
S	52	62	74	74	86	108	132	166	166
*SW ^{H7}	7,2	9,06	14,04	11,15	16	20	25	30	35
T	15	18	22	22	25	32	40	50	50

* = Customized bores, key-ways and inner hexagon dimensions possible

Md_{max} = Max. permissible torque

β = Max. angle of deflection per joint

For application criteria and calculations refer to technical annex

■ TIP ■

There are application examples in which frequent removal of the universal joint shaft or the joint from the drive or the output shaft is required.

In this case the use of a rapid-change coupling allows to change the shaft within very short time. This is done manually without any tools.

Torque transmission is ensured via a hexagonal profile or a feather key. Two steel balls which grip into a circular groove at the shaft connection provide axial locking of the shaft.



double, with length compensation, Standard bore

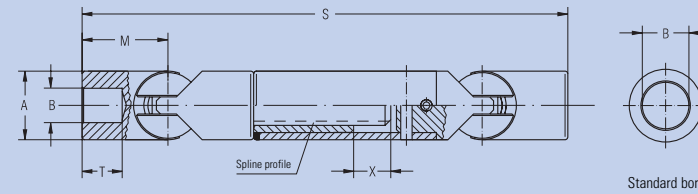
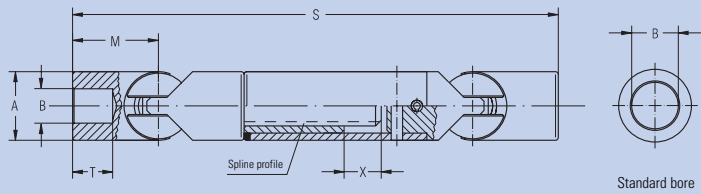

When ordering, please indicate compressed length and extension!

Ball and Socket Shafts, double, Standard bore

Order number		0.820.100	0.824.100	0.828.100	0.832.100	0.836.100	0.840.100	0.845.100
Md _{max}	Nm	20	30	50	60	120	160	200
Angle of deflection β	°	35	35	35	35	35	35	35
Weight by S ₁	kg	0,32	0,50	0,78	1,10	1,58	2,17	2,92
Weight by S ₂	kg	0,36	0,58	0,85	1,22	1,72	2,28	3,38
Weight by S ₃	kg	0,40	0,62	0,98	1,33	1,82	2,52	3,68
A	mm	20	24	28	32	36	40	45
*B ^{H7}	mm	10	12	14	16	18	20	22
*C ^{+0,2}	mm	–	–	–	–	–	–	–
*D ^{P9}	mm	–	–	–	–	–	–	–
*E ^{H9}	mm	–	–	–	–	–	–	–
M	mm	25	30	35	40	45	50	55
S ₁ + X ₁	mm	150 + 20	170 + 25	200 + 30	220 + 30	250 + 35	280 + 40	300 + 40
S ₂ + X ₂	mm	170 + 40	200 + 55	220 + 50	250 + 60	280 + 65	300 + 60	350 + 90
S ₃ + X ₃	mm	200 + 70	220 + 75	250 + 80	280 + 90	300 + 85	350 + 110	400 + 140
T	mm	13	14	17	19	22	24	26
Spline profile	mm	6x11x14	6x11x14	6x16x20	6x16x20	6x18x22	6x21x25	6x21x25

	0.850.100	0.855.100	0.860.100	0.865.100	0.870.100	0.880.100	0.890.100	0.896.100
Md _{max}	290	440	520	700	820	930	1060	1250
Angle of deflection β	35	35	35	35	35	35	35	35
Weight by S ₁	4,27	5,50	7,78	10,4	13,6	20,1	27,7	35,8
Weight by S ₂	4,58	5,98	8,45	10,8	14,7	21,9	30,6	38,7
Weight by S ₃	5,18	6,62	9,58	11,8	16,2	24,5	33,5	41,7
A	50	55	60	65	70	80	90	100
*B ^{H7}	25	30	35	40	45	50	60	70
*C ^{+0,2}	–	–	–	–	–	–	–	–
*D ^{P9}	–	–	–	–	–	–	–	–
*E ^{H9}	–	–	–	–	–	–	–	–
M	62,5	67,5	82,5	95	105	115	130	145
S ₁ + X ₁	350 + 50	400 + 50	450 + 50	520 + 70	580 + 70	630 + 70	700 + 70	800 + 100
S ₂ + X ₂	400 + 100	450 + 100	500 + 100	550 + 100	630 + 120	700 + 140	800 + 170	900 + 200
S ₃ + X ₃	450 + 150	500 + 160	580 + 180	630 + 180	700 + 190	800 + 240	900 + 270	1000 + 300
T	30	35	42	46	52	58	70	80
Spline profile	6x28x32	6x28x32	6x36x42	6x36x42	52x44x18	58x50x18	62x54x20	62x54x20

* = Customized bores, key-ways and inner square dimensions possible
 Md_{max} = Max. permissible torque
 β = Max. angle of deflection per joint
 S₁
 S₂ = preferred lengths, compressed
 S₃
 X₁ = Maximum extension for S₁
 X₂ = Maximum extension for S₂
 X₃ = Maximum extension for S₃
 For application criteria and calculations refer to technical annex

double, with length compensation, Bore with key-way DIN 6885, Sheet 1

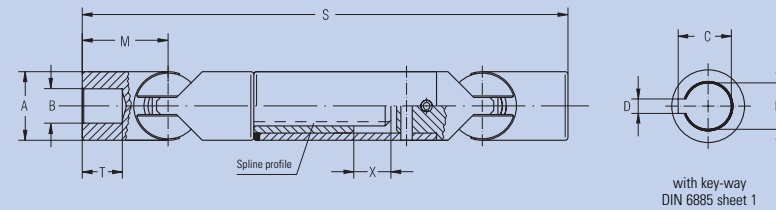
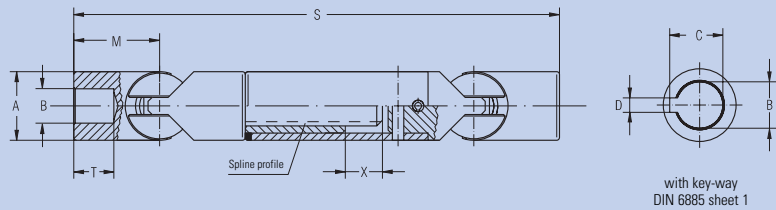

When ordering, please indicate compressed length and extension!

Ball and Socket Shafts, double, Bore with key-way DIN 6885, Sheet 1

Order number	0.820.103	0.824.103	0.828.103	0.832.103	0.836.103	0.840.103	0.845.103
Md _{max}	Nm 20	30	50	60	120	160	200
Angle of deflection β	° 35	35	35	35	35	35	35
Weight by S ₁	kg 0,32	0,50	0,78	1,10	1,58	2,17	2,92
Weight by S ₂	kg 0,36	0,58	0,85	1,22	1,72	2,28	3,38
Weight by S ₃	kg 0,40	0,62	0,98	1,33	1,82	2,52	3,68
A	mm 20	24	28	32	36	40	45
*B ^{H7}	mm 10	12	14	16	18	20	22
*C ^{H/2}	mm 11,4	13,8	16,3	18,3	20,8	22,8	24,8
*D ^{P9}	mm 3	4	5	5	6	6	6
*E ^{H9}	mm –	–	–	–	–	–	–
M	mm 25	30	35	40	45	50	55
S ₁ + X ₁	mm 150 + 20	170 + 25	200 + 30	220 + 30	250 + 35	280 + 40	300 + 40
S ₂ + X ₂	mm 170 + 40	200 + 55	220 + 50	250 + 60	280 + 65	300 + 60	350 + 90
S ₃ + X ₃	mm 200 + 70	220 + 75	250 + 80	280 + 90	300 + 85	350 + 110	400 + 140
T	mm 13	14	17	19	22	24	26
Spline profile	mm 6x11x14	6x11x14	6x16x20	6x16x20	6x18x22	6x21x25	6x21x25

0.850.103	0.855.103	0.860.103	0.865.103	0.870.103	0.880.103	0.890.103	0.896.103
290	440	520	700	820	930	1060	1250
35	35	35	35	35	35	35	35
4,27	5,50	7,78	10,4	13,6	20,1	27,7	35,8
4,58	5,98	8,45	10,8	14,7	21,9	30,6	38,7
5,18	6,62	9,58	11,8	16,2	24,5	33,5	41,7
50	55	60	65	70	80	90	100
25	30	35	40	45	50	60	70
28,3	33,3	38,3	43,3	48,8	53,8	64,4	74,9
8	8	10	12	14	14	18	20
–	–	–	–	–	–	–	–
62,5	67,5	82,5	95	105	115	130	145
350 + 50	400 + 50	450 + 50	520 + 70	580 + 70	630 + 70	700 + 70	800 + 100
400 + 100	450 + 100	500 + 100	550 + 100	630 + 120	700 + 140	800 + 170	900 + 200
450 + 150	500 + 160	580 + 180	630 + 180	700 + 190	800 + 240	900 + 270	1000 + 300
30	35	42	46	52	58	70	80
6x28x32	6x28x32	6x36x42	6x36x42	52x44x18	58x50x18	62x54x20	62x54x20

* = Customized bores, key-ways and inner square dimensions possible
 Md_{max} = Max. permissible torque
 β = Max. angle of deflection per joint
 S₁
 S₂ = preferred lengths, compressed
 S₃
 X₁ = Maximum extension for S₁
 X₂ = Maximum extension for S₂
 X₃ = Maximum extension for S₃
 For application criteria and calculations refer to technical annex

double, with length compensation, Inner square

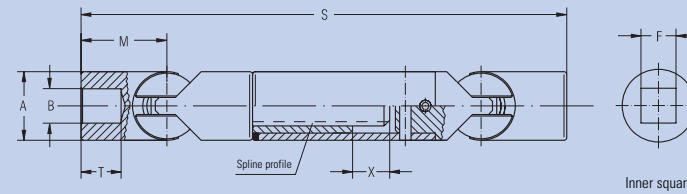
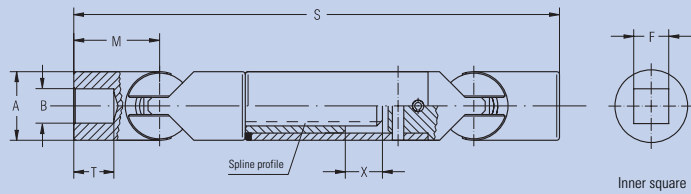

When ordering, please indicate compressed length and extension!

Ball and Socket Shafts, double, Inner square

Order number	0.820.104	0.824.104	0.828.104	0.832.104	0.836.104	0.840.104	0.845.104
Md _{max}	Nm 20	30	50	60	120	160	200
Angle of deflection β	° 35	35	35	35	35	35	35
Weight by S ₁	kg 0,32	0,50	0,78	1,10	1,58	2,17	2,92
Weight by S ₂	kg 0,36	0,58	0,85	1,22	1,72	2,28	3,38
Weight by S ₃	kg 0,40	0,62	0,98	1,33	1,82	2,52	3,68
A	mm 20	24	28	32	36	40	45
*B ^{H7}	mm –	–	–	–	–	–	–
*C ^{+0,2}	mm –	–	–	–	–	–	–
*D ^{P9}	mm –	–	–	–	–	–	–
*E ^{H9}	mm 10	12	14	16	18	20	22
M	mm 25	30	35	40	45	50	55
S ₁ + X ₁	mm 150 + 20	170 + 25	200 + 30	220 + 30	250 + 35	280 + 40	300 + 40
S ₂ + X ₂	mm 170 + 40	200 + 55	220 + 50	250 + 60	280 + 65	300 + 60	350 + 90
S ₃ + X ₃	mm 200 + 70	220 + 75	250 + 80	280 + 90	300 + 85	350 + 110	400 + 140
T	mm 13	14	17	19	22	24	26
Spline profile	mm 6x11x14	6x11x14	6x16x20	6x16x20	6x18x22	6x21x25	6x21x25

0.850.104	0.855.104	0.860.104	0.865.104	0.870.104	0.880.104	0.890.104	0.896.104
290	440	520	700	820	930	1060	1250
35	35	35	35	35	35	35	35
4,27	5,50	7,78	10,4	13,6	20,1	27,7	35,8
4,58	5,98	8,45	10,8	14,7	21,9	30,6	38,7
5,18	6,62	9,58	11,8	16,2	24,5	33,5	41,7
50	55	60	65	70	80	90	100
–	–	–	–	–	–	–	–
–	–	–	–	–	–	–	–
–	–	–	–	–	–	–	–
25	30	32	36	40	42	50	54
62,5	67,5	82,5	95	105	115	130	145
350 + 50	400 + 50	450 + 50	520 + 70	580 + 70	630 + 70	700 + 70	800 + 100
400 + 100	450 + 100	500 + 100	550 + 100	630 + 120	700 + 140	800 + 170	900 + 200
450 + 150	500 + 160	580 + 180	630 + 180	700 + 190	800 + 240	900 + 270	1000 + 300
30	35	42	46	52	58	70	80
6x28x32	6x28x32	6x36x42	6x36x42	52x44x18	58x50x18	62x54x20	62x54x20

* = Customized bores, key-ways and inner square dimensions possible
 Md_{max} = Max. permissible torque
 β = Max. angle of deflection per joint
 S₁
 S₂ = preferred lengths, compressed
 S₃
 X₁ = Maximum extension for S₁
 X₂ = Maximum extension for S₂
 X₃ = Maximum extension for S₃
 For application criteria and calculations refer to technical annex

double, Standard bore

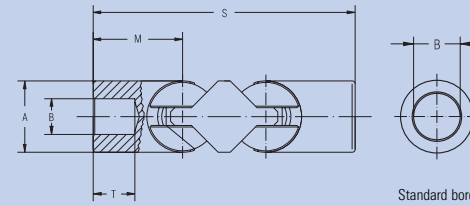
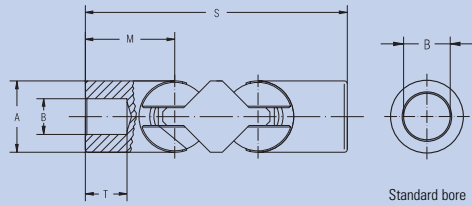

Ball and Socket Joints, double, Standard bore

Order number		0.820.300	0.824.300	0.828.300	0.832.300	0.836.300	0.840.300	0.845.300
Md _{max}	Nm	20	30	50	60	120	160	200
Angle of deflection β	°	35	35	35	35	35	35	35
Weight	kg	0,14	0,22	0,38	0,55	0,78	1,08	1,48
A	mm	20	24	28	32	36	40	45
*B ^{H7}	mm	10	12	14	16	18	20	22
*C ^{+0,2}	mm	–	–	–	–	–	–	–
*D ^{F9}	mm	–	–	–	–	–	–	–
*E ^{H9}	mm	–	–	–	–	–	–	–
M	mm	25	30	35	40	45	50	55
S	mm	74	88	103	118	133	148	163
T	mm	13	14	17	19	22	24	26

* = Customized bores, key-ways and inner square dimensions possible
 Md_{max} = Max. permissible torque
 For application criteria and calculations refer to technical annex

	0.850.300	0.855.300	0.860.300	0.865.300	0.870.300	0.880.300	0.890.300	0.896.300	0.897.300
Md _{max}	290	440	520	700	820	930	1060	1250	1370
Angle of deflection β	35	35	35	35	35	35	35	35	35
Weight	2,08	2,62	3,65	4,78	5,88	8,52	11,7	15,5	21,8
A	50	55	60	65	70	80	90	100	110
*B ^{H7}	25	30	35	40	45	50	60	70	75
*C ^{+0,2}	–	–	–	–	–	–	–	–	–
*D ^{F9}	–	–	–	–	–	–	–	–	–
*E ^{H9}	–	–	–	–	–	–	–	–	–
M	62,5	67,5	82,5	95	105	115	130	145	160
S	185	200	237	267	292	322	362	404	444
T	30	35	42	46	52	58	70	80	85



0.800

double, Bore with key-way DIN 6885, Sheet 1; Inner square

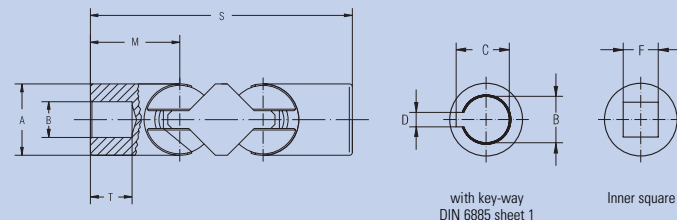
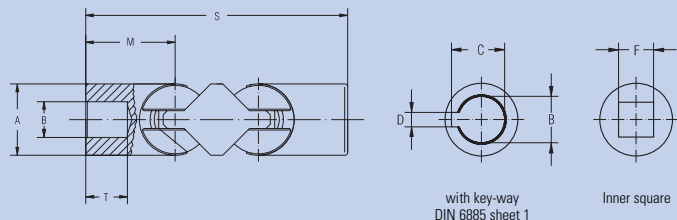

Ball and Socket Joints, double, Bore with key-way DIN 6885, Sheet 1

Order number		0.820.303	0.824.303	0.828.303	0.832.303	0.836.303	0.840.303	0.845.303
Md _{max}	Nm	20	30	50	60	120	160	200
Angle of deflection β	°	35	35	35	35	35	35	35
Weight	kg	0,14	0,22	0,38	0,55	0,78	1,08	1,48
A	mm	20	24	28	32	36	40	45
*B ^{H7}	mm	10	12	14	16	18	20	22
*C ^{+0,2}	mm	11,4	13,8	16,3	18,3	20,8	22,8	24,8
*D ^{P9}	mm	3	4	5	5	6	6	6
*E ^{H9}	mm	–	–	–	–	–	–	–
M	mm	25	30	35	40	45	50	55
S	mm	74	88	103	118	133	148	163
T	mm	13	14	17	19	22	24	26

0.850.303	0.855.303	0.860.303	0.865.303	0.870.303	0.880.303	0.890.303	0.896.303	0.897.303
290	440	520	700	820	930	1060	1250	1370
35	35	35	35	35	35	35	35	35
2,08	2,62	3,65	4,78	5,88	8,52	11,7	15,5	21,8
50	55	60	65	70	80	90	100	110
25	30	35	40	45	50	60	70	75
28,3	33,3	38,3	43,3	48,8	53,8	64,4	74,9	79,9
8	8	10	12	14	14	18	20	20
–	–	–	–	–	–	–	–	–
62,5	67,5	82,5	95	105	115	130	145	160
185	200	237	267	292	322	362	404	444
30	35	42	46	52	58	70	80	85

Ball and Socket Joints, double, Inner square

Order number		0.820.304	0.824.304	0.828.304	0.832.304	0.836.304	0.840.304	0.845.304
Md _{max}	Nm	20	30	50	60	120	160	200
Angle of deflection β	°	35	35	35	35	35	35	35
Weight	kg	0,14	0,22	0,38	0,55	0,78	1,08	1,48
A	mm	20	24	28	32	36	40	45
*B ^{H7}	mm	–	–	–	–	–	–	–
*C ^{+0,2}	mm	–	–	–	–	–	–	–
*D ^{P9}	mm	–	–	–	–	–	–	–
*E ^{H9}	mm	10	12	14	16	18	20	22
M	mm	25	30	35	40	45	50	55
S	mm	74	88	103	118	133	148	163
T	mm	13	14	17	19	22	24	26

0.850.304	0.855.304	0.860.304	0.865.304	0.870.304	0.880.304	0.890.304	0.896.304	0.897.304
290	440	520	700	820	930	1060	1250	1370
35	35	35	35	35	35	35	35	35
2,08	2,62	3,65	4,78	5,88	8,52	11,7	15,5	21,8
50	55	60	65	70	80	90	100	110
–	–	–	–	–	–	–	–	–
–	–	–	–	–	–	–	–	–
25	30	32	36	40	42	50	54	58
62,5	67,5	82,5	95	105	115	130	145	160
185	200	237	267	292	322	362	404	444
30	35	42	46	52	58	70	80	85

* = Customized bores, key-ways and inner square dimensions possible
 Md_{max} = Max. permissible torque
 For application criteria and calculations refer to technical annex

single, Standard bore

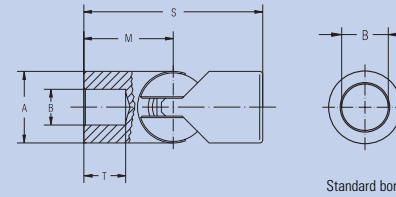
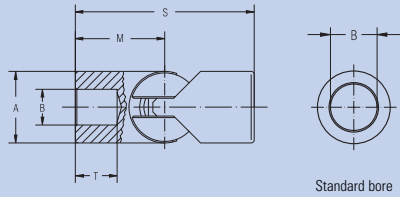

Ball and Socket Joints, single, Standard bore

Order number		0.813.400	0.816.400	0.820.400	0.824.400	0.828.400	0.832.400	0.836.400	0.840.400
Md _{max}	Nm	6	8	20	30	50	60	120	160
Angle of deflection β	°	35	35	35	35	35	35	35	35
Weight	kg	0,03	0,05	0,09	0,15	0,24	0,36	0,53	0,72
A	mm	13	16	20	24	28	32	36	40
*B ^{H7}	mm	6	8	10	12	14	16	18	20
*C ^{+0,2}	mm	–	–	–	–	–	–	–	–
*D ^{F9}	mm	–	–	–	–	–	–	–	–
*E ^{H9}	mm	–	–	–	–	–	–	–	–
M	mm	17,5	20	25	30	35	40	45	50
S	mm	35	40	50	60	70	80	90	100
T	mm	10	10	13	14	17	19	22	24

* = Customized bores, key-ways an inner square dimensions possible
 Md_{max} = Max. permissible torque
 For application criteria and calculations refer to technical annex

0.845.400	0.850.400	0.855.400	0.860.400	0.865.400	0.870.400	0.880.400	0.890.400	0.896.400	0.897.400
200	290	440	520	700	820	930	1060	1250	1370
35	35	35	35	35	35	35	35	35	35
1,02	1,40	1,75	2,52	3,32	4,15	6,02	8,04	10,6	15,3
45	50	55	60	65	70	80	90	100	110
22	25	30	35	40	45	50	60	70	75
–	–	–	–	–	–	–	–	–	–
–	–	–	–	–	–	–	–	–	–
–	–	–	–	–	–	–	–	–	–
55	62,5	67,5	82,5	95	105	115	130	145	160
110	125	135	165	190	210	230	260	290	320
26	30	35	42	46	52	58	70	80	85

single, Bore with key-way DIN 6885, Sheet 1; Inner square

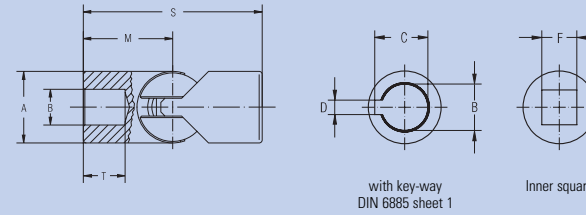
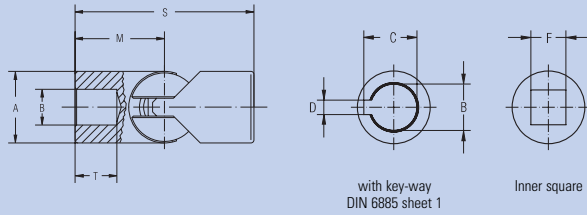

Ball and Socket Joints, single, Bore with Key-way DIN 6885, Sheet 1

Order number		0.820.403	0.824.403	0.828.403	0.832.403	0.836.403	0.840.403
Md _{max}	Nm	20	30	50	60	120	160
Angle of deflection β	°	35	35	35	35	35	35
Weight	kg	0,09	0,15	0,24	0,36	0,53	0,72
A	mm	20	24	28	32	36	40
*B ^{H7}	mm	10	12	14	16	18	20
*C ^{H2}	mm	11,4	13,8	16,3	18,3	20,8	22,8
*D ^{P9}	mm	3	4	5	5	6	6
*E ^{H8}	mm	–	–	–	–	–	–
M	mm	25	30	35	40	45	50
S	mm	50	60	70	80	90	100
T	mm	13	14	17	19	22	24

0.845.403	0.850.403	0.855.403	0.860.403	0.865.403	0.870.403	0.880.403	0.890.403	0.896.403	0.897.403
200	290	440	520	700	820	930	1060	1250	1370
35	35	35	35	35	35	35	35	35	35
1,02	1,40	1,75	2,52	3,32	4,15	6,02	8,04	10,6	15,3
45	50	55	60	65	70	80	90	100	110
22	25	30	35	40	45	50	60	70	75
24,8	28,3	33,3	38,3	43,3	48,8	53,3	64,4	74,9	79,9
6	8	8	10	12	14	14	18	20	20
–	–	–	–	–	–	–	–	–	–
55	62,5	67,5	82,5	95	105	115	130	145	160
110	125	135	165	190	210	230	260	290	320
26	30	35	42	46	52	58	70	80	85

Ball and Socket Joints, single, Inner square

Order number		0.820.404	0.824.404	0.828.404	0.832.404	0.836.404	0.840.404
Md _{max}	Nm	20	30	50	60	120	160
Angle of deflection β	°	35	35	35	35	35	35
Weight	kg	0,09	0,15	0,24	0,36	0,53	0,72
A	mm	20	24	28	32	36	40
*B ^{H7}	mm	–	–	–	–	–	–
*C ^{H2}	mm	–	–	–	–	–	–
*D ^{P9}	mm	–	–	–	–	–	–
*E ^{H8}	mm	10	12	14	16	18	20
M	mm	25	30	35	40	45	50
S	mm	50	60	70	80	90	100
T	mm	13	14	17	19	22	24

0.845.404	0.850.404	0.855.404	0.860.404	0.865.404	0.870.404	0.880.404	0.890.404	0.896.404	0.897.404
200	290	440	520	700	820	930	1060	1250	1370
35	35	35	35	35	35	35	35	35	35
1,02	1,40	1,75	2,52	3,32	4,15	6,02	8,04	10,6	15,3
45	50	55	60	65	70	80	90	100	110
–	–	–	–	–	–	–	–	–	–
–	–	–	–	–	–	–	–	–	–
22	25	30	32	36	40	42	50	54	58
55	62,5	67,5	82,5	95	105	115	130	145	160
110	125	135	165	190	210	230	260	290	320
26	30	35	42	46	52	58	70	80	85

* = Customized bores, key-ways an inner square dimensions possible
 Md_{max} = Max. permissible torque
 For application criteria and calculations refer to technical annex

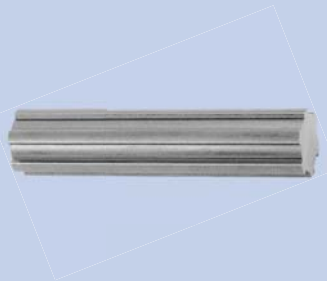

Spline Shafts DIN ISO 14

Material: C40 k, 1.0511 oder C45 k, 1.0503
Material: 35 S 20 k, 1.0726

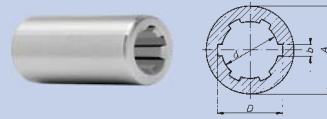

Spline Bore Hubs DIN ISO 14

Material: 9 SMn Pb 28 k, 1.0718

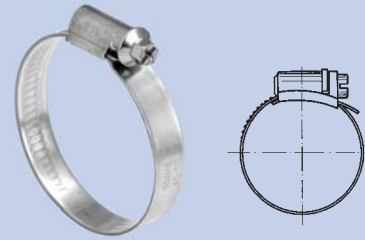

Material: steel, zinc-plated or stainless steel, corrosion- and acid-resistant

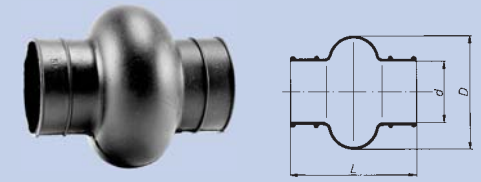

Material: neoprene; temperature-resistant up to 100 °C

Also available with Spigots

Spline Shafts DIN ISO 14

Order number	1.000.524.001	1.000.524.002	1.000.524.003	1.000.524.004	1.000.524.005	1.000.524.007	1.000.524.006
Designation	B 6 x 11 x 14	B 6 x 16 x 20	B 6 x 18 x 22	B 6 x 21 x 25	B 6 x 28 x 32	B 6 x 28 x 34	B 6 x 36 x 42
D	mm 14	mm 20	mm 22	mm 25	mm 32	mm 34	mm 42
d	mm 11	mm 16	mm 18	mm 21	mm 28	mm 28	mm 36
b	mm 3	mm 4	mm 5	mm 5	mm 7	mm 7	mm 8
Available in all lengths up to	mm 3000	mm 3000	mm 3000	mm 3000	mm 500*	mm 3000	mm 500*

Material: C40 k, 1.0511 oder C45 k, 1.0503
* = Material: 35 S 20 k, 1.0726

Spline Bore Hubs DIN ISO 14

Order number	1.000.511.001	1.000.511.002	1.000.511.003	1.000.511.004	1.000.511.005	1.000.511.007	1.000.511.006
Designation	A 6 x 11 x 14	A 6 x 16 x 20	A 6 x 18 x 22	A 6 x 21 x 25	A 6 x 28 x 32	A 6 x 28 x 34	A 6 x 36 x 42
D	mm 14	mm 20	mm 22	mm 25	mm 32	mm 34	mm 42
d	mm 11	mm 16	mm 18	mm 21	mm 28	mm 28	mm 36
b	mm 3	mm 4	mm 5	mm 5	mm 7	mm 7	mm 8
A	mm 20	mm 28	mm 36	mm 40	mm 50	mm 50	mm 60
Lenght*	mm 50	mm 60	mm 70	mm 70	mm 80	mm 60	mm 100

* = max. grip length even
Material: 9 SMn Pb 28 k, 1.0718

Hose Clips, steel, zinc-plated

Order number	1.000.961.011	1.000.961.029	1.000.961.003	1.000.961.006	1.000.961.012	1.000.961.013	1.000.961.014	1.000.961.010
Joint-size	0.716/0.816/ 0.720/0.820	0.824/0.725/ 0.828	0.732/0.832/ 0.836	0.740/0.840/ 0.845	0.750/0.850/ 0.855	0.860/0.865	0.870	0.880
Clamping range	mm 12 – 20	mm 20 – 32	mm 25 – 40	mm 32 – 50	mm 40 – 60	mm 50 – 70	mm 60 – 80	mm 70 – 90

Hose Clips, stainless steel, corrosion- and acid-resistant

Order number	1.000.961.020	1.000.961.022	1.000.961.023	1.000.961.024	1.000.961.025	1.000.961.026	1.000.961.027	1.000.961.028
Joint-size	0.716/0.816/ 0.720/0.820	0.824/0.725/ 0.828	0.732/0.832/ 0.836	0.740/0.840/ 0.845	0.750/0.850/ 0.855	0.860/0.865	0.870	0.880
Clamping range	mm 12 – 20	mm 20 – 32	mm 25 – 40	mm 32 – 50	mm 40 – 60	mm 50 – 70	mm 60 – 80	mm 70 – 90

Bellows

Order number	1.000.830.009	1.000.830.010	1.000.830.013	1.000.830.014	1.000.830.002	1.000.830.003
Joint-size	0.716/0.816	0.720/0.820	0.725/0.824	0.828	0.732/0.832	0.836
L	mm 40	mm 47	mm 52	mm 58	mm 67	mm 74
D	mm 31	mm 33	mm 46	mm 50	mm 54	mm 65
d	mm 16	mm 20	mm 25	mm 28	mm 32	mm 36

Order number	1.000.830.004	1.000.830.015	1.000.830.016	1.000.830.006	1.000.830.007	1.000.830.017
Joint-size	0.740/0.840	0.845	0.750/0.850	0.855/0.860	0.865/0.870	0.880
L	mm 84	mm 97	mm 110	mm 122	mm 132	mm 157
D	mm 75	mm 82	mm 90	mm 100	mm 110	mm 131
d	mm 040	mm 45	mm 50	mm 56	mm 65	mm 80

with extension, Roller bearing

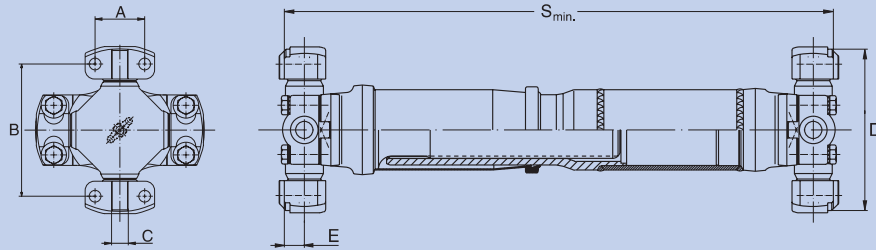

Built 110, Tubular Type, larger extension
end number: 0.9XX.110

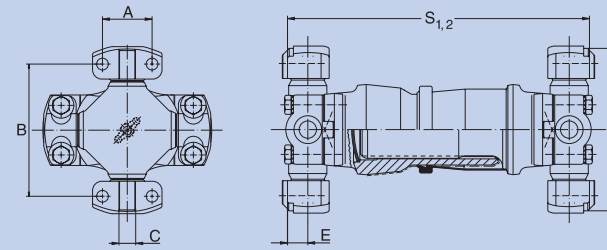

Built 130, Short Type
end number: 0.9XX.130

Additional length and types on request.

Wing-Style, Tubular Type, larger extension, Roller bearing version

Order number		0.950.110	0.960.110	0.970.110	0.980.110	0.985.110	0.990.110
Series		5C	6C	7C	8C	8.5C	9C
Md _{max}	Nm	2500	4000	5400	7600	9000	13200
Angle of deflection β	°	25	25	25	30	25	25
S _{min}	mm	400	402	465	555	575	575
S ₁	mm	–	–	–	–	–	–
S ₂	mm	–	–	–	–	–	–
X	mm	105	105	110	110	110	110
X ₁	mm	–	–	–	–	–	–
X ₂	mm	–	–	–	–	–	–
P ₁	mm	60 x 4	70 x 4	80 x 4	90 x 4	100 x 5	110 x 6
Spline dim. DIN 5480	mm	42 x 2,0 x 20	50 x 2,0 x 24	55 x 2,5 x 20	60 x 2,5 x 22	65 x 2,5 x 24	75 x 2,5 x 28
A _{±0,2}	mm	42,9	42,9	49,2	49,2	71,4	71,4
B _{±0,2}	mm	88,9	114,3	117,5	174,7	123,9	168,3
C _{±0,8}	mm	14,26	14,26	15,85	15,85	15,85	15,85
D _{-0,4}	mm	115,06	140,46	148,39	206,32	165,08	209,52
E (Subtraction measure)	mm	17,5	17,5	20,6	20,6	25,4	25,4

Md_{max} = Maximum permitted torque. See technical annex
 β = Maximum angle of deflection
 S_{min} = Minimum length of tubular types
 S₁ = Compressed lengths
 S₂ = of short types
 X₁ = Extension at S_{min} resp. S₁
 X₂ = Extension at S₂
 P₁ = Tube diameter. Dimensions in bold type for normal applications.
 Alternative dimensions are for long shafts at high speeds, see technical annex domain speed

Additional length and types on request.

Wing-Style, Short Type, Roller bearing version

Order number		–	0.960.130	0.970.130	0.980.130	0.985.130	0.990.130
Series		–	6C	7C	8C	8.5C	9C
Md _{max}	Nm	–	4000	5400	7600	9000	13200
Angle of deflection β	°	–	25	25	30	25	25
S _{min}	mm	–	–	–	–	–	–
S ₁	mm	–	260	292	315	330	370
S ₂	mm	–	–	–	–	–	–
X	mm	–	–	–	–	–	–
X ₁	mm	–	45	50	45	45	45
X ₂	mm	–	–	–	–	–	–
P ₁	mm	–	–	–	–	–	–
Spline dim. DIN 5480	mm	–	50 x 2,0 x 24	55 x 2,5 x 20	60 x 2,5 x 22	65 x 2,5 x 24	75 x 2,5 x 28
A _{±0,2}	mm	–	42,9	49,2	49,2	71,4	71,4
B _{±0,2}	mm	–	114,3	117,5	174,7	123,9	168,3
C _{±0,8}	mm	–	14,26	15,85	15,85	15,85	15,85
D _{-0,4}	mm	–	140,46	148,39	206,32	165,08	209,52
E (Subtraction measure)	mm	–	17,5	20,6	20,6	25,4	25,4

Md_{max} = Maximum permitted torque. See technical annex
 β = Maximum angle of deflection
 S_{min} = Minimum length of tubular types
 S₁ = Compressed lengths
 S₂ = of short types
 X₁ = Extension at S_{min} resp. S₁
 X₂ = Extension at S₂
 P₁ = Tube diameter. Dimensions in bold type for normal applications.
 Alternative dimensions are for long shafts at high speeds, see technical annex domain speed

without extension, Roller bearing

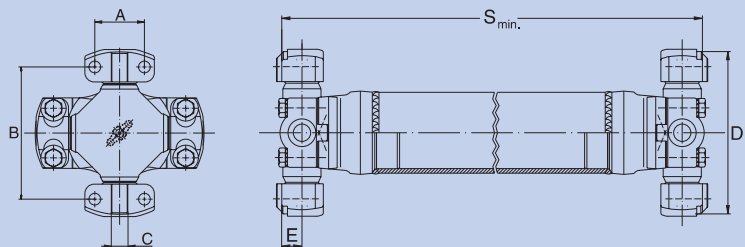

Built 200, Tubular Type
end number: 0.9XX.200

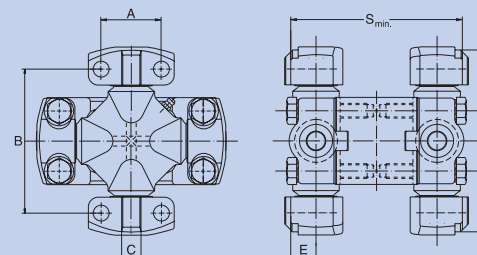

Built 300 Universal Joint double
end number: 0.9XX.300

Additional length and types on request.

Wing-Style, Tubular Type, Roller bearing version

Order number		0.950.200	0.960.200	0.970.200	0.980.200	0.985.200	0.990.200
Series		5C	6C	7C	8C	8.5C	9C
Md _{max}	Nm	2500	4000	5400	7600	9000	13200
Angle of deflection β	°	25	25	25	30	25	25
S _{min}	mm	205	206	245	275	315	295
S ₁	mm	–	–	–	–	–	–
S ₂	mm	–	–	–	–	–	–
X	mm	–	–	–	–	–	–
X ₁	mm	–	–	–	–	–	–
X ₂	mm	–	–	–	–	–	–
P ₁	mm	60 x 4	70 x 4	80 x 4	90 x 4	100 x 5	110 x 6
Spline dim. DIN 5480	mm	–	–	–	–	–	–
A _{±0.2}	mm	42,9	42,9	49,2	49,2	71,4	71,4
B _{±0.2}	mm	88,9	114,3	117,5	174,7	123,9	168,3
C _{±0.8}	mm	14,26	14,26	15,85	15,85	15,85	15,85
D _{-0.4}	mm	115,06	140,46	148,39	206,32	165,08	209,52
E (Subtraction measure)	mm	17,5	17,5	20,6	20,6	25,4	25,4

Md_{max} = Maximum permitted torque. See technical annex
 β = Maximum angle of deflection
 S_{min} = Minimum length of tubular types
 S₁ = Compressed lengths
 S₂ = of short types
 X₁ = Extension at S_{min} resp. S₁
 X₂ = Extension at S₂
 P₁ = Tube diameter. Dimensions in bold type for normal applications.
 Alternative dimensions are for long shafts at high speeds, see technical annex domain speed

Additional length and types on request.

Wing-Style, Universal Joint Double, Roller bearing version

Order number		0.950.300	0.960.300	0.970.300	–	0.985.300	–
Series		5C	6C	7C	–	8.5C	–
Md _{max}	Nm	2500	4000	5400	–	9000	–
Angle of deflection β	°	10	25	10	–	10	–
S _{min}	mm	141	188	140	–	169	–
S ₁	mm	–	–	–	–	–	–
S ₂	mm	–	–	–	–	–	–
X	mm	–	–	–	–	–	–
X ₁	mm	–	–	–	–	–	–
X ₂	mm	–	–	–	–	–	–
P ₁	mm	–	–	–	–	–	–
Spline dim. DIN 5480	mm	–	–	–	–	–	–
A _{±0.2}	mm	42,9	42,9	49,2	–	71,4	–
B _{±0.2}	mm	88,9	114,3	117,5	–	123,9	–
C _{±0.8}	mm	14,26	14,26	15,85	–	15,85	–
D _{-0.4}	mm	115,06	140,46	148,39	–	165,08	–
E (Subtraction measure)	mm	17,5	17,5	20,6	–	25,4	–

Md_{max} = Maximum permitted torque. See technical annex
 β = Maximum angle of deflection
 S_{min} = Minimum length of tubular types
 S₁ = Compressed lengths
 S₂ = of short types
 X₁ = Extension at S_{min} resp. S₁
 X₂ = Extension at S₂
 P₁ = Tube diameter. Dimensions in bold type for normal applications.
 Alternative dimensions are for long shafts at high speeds, see technical annex domain speed

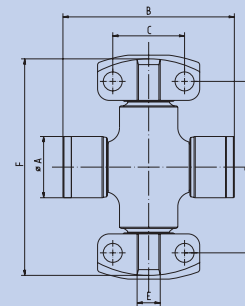
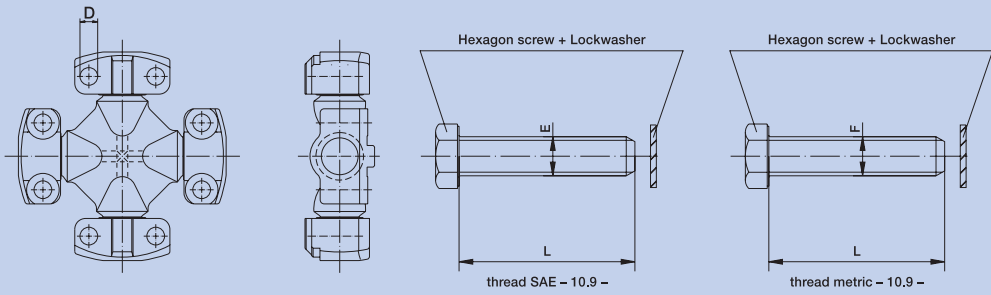

Combination cross kits

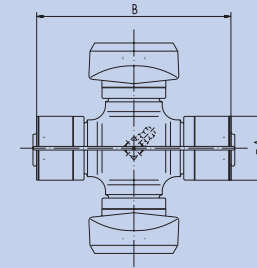

Cross kits for Half Round Yokes

Cross Units, Roller bearing version

Order number	0.950.023	0.960.023	0.970.023	0.980.023	0.985.023	0.990.023
Series	5C	6C	7C	8C	8.5C	9C
bore dimension Ø D	mm	10,2 ^{+0,4}	10,2 ^{+0,4}	13,0 ^{+0,4}	13,0 ^{+0,4}	13,0 ^{+0,4}

Screw kit SAE – 10.9 –

Order number	0.950.192.001	0.970.192.001	0.985.192.001	
thread Ø E x L	inch	3/8"-24-UNF x 1 3/4"	1/2"-20-UNF x 2"	1/2"-20-UNF x 63,5
Screw torque	Nm	62,4	135,7	135,7
used for		0.950.023/0.960.023	0.970.023/0.980.023	0.985.023/0.990.023

Screw kit metric – 10.9 –

Order number	0.950.192.002	0.970.192.002	0.985.192.002	
thread Ø F x L	mm	M10 x 1,25 x 45	M12 x 1,5 x 52	M12 x 1,5 x 60
Screw torque	Nm	70,4	120,7	120,7
used for		0.950.023/0.960.023	0.970.023/0.980.023	0.985.023/0.990.023

Combination cross kits, Roller bearing version

Order number	0.950.023.015	0.950.023.011/012	0.960.023.016	0.960.023.019	0.960.023.017	0.970.023.012	
Grease nipple	no	no	no	yes	no	no	
Ø A	mm	35	38	38	48	42	
B	mm	97	106	106	126	117,5	
C	mm	42,9	42,9	42,9	42,9	49,2	
D	mm	88,9	88,9	114,3	114,3	117,5	
E	mm	14,26	14,26	14,26	14,26	15,85	
F	mm	115,06	115,06	140,46	140,46	148,39	
used for		5C/112	5C/113	6C/113	6C/113	6C/158	7C/148

Cross kits for Half Round Yokes, Roller bearing

Order number	0.100.015.011	0.112.015.013	
Ø A	mm	34,915 ^{+0,015}	34,915 ^{+0,015}
B	mm	126,1	106,26 ^{+0,1}
used for / description		0.100.259.011/intermediate shaft	0.100.300.220/Universal Joint double

In vehicle construction and mechanical engineering drive flanges form the connection between drive and cardan shaft.

Using modern machine equipment, we manufacture products on the basis of high-quality forgings according to customer drawings.

The drive flanges can be manufactured with internal and external splines as well as with hardened and lead-free ground seal bearing surface.

Please refer to the following pages for further information on our product range.



Design: end plate
 – Induction-hardened and lead-free ground seal bearing surface
 – Internal splines

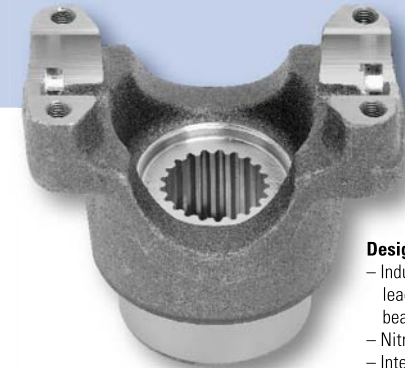

Design: half round
 – Induction-hardened and lead-free ground seal bearing surface
 – Nitrided
 – Internal splines



Design according to DIN ISO 8667
 – Induction-hardened and lead-free ground seal bearing surface
 – Internal splines
 – Cross-serration 70°



Design: rectangular
 – Induction-hardened and lead-free ground seal bearing surface
 – Internal splines

Design: triangular
 – Induction-hardened and lead-free ground seal bearing surface
 – Internal splines



Special design: wing style
 – Induction-hardened and lead-free ground seal bearing surface
 – Internal splines

Design according to DIN 7646
 – Induction-hardened and lead-free ground seal bearing surface
 – Case-hardened version
 – Internal splines



Design: wing style
 – Induction-hardened and lead-free ground seal bearing surface
 – Nitrided
 – Internal splines

The main application field of our spiders is the integration into cardan joints. The spider is the main component of the cardan joint. Spiders, however, are also used in numerous other applications.

Our product range includes e.g. also so-called „compensation spiders“ for differential gears and spiders for tool technology.

Our spiders are made of high-quality pressed or forged blanks. Processing such as turning, case-hardening and grinding is carried out at our production facilities and strict quality control processes are adhered to.

General technical data for spiders:

Trunnion diameter: 4 mm to 48 mm

For torque range: 6 Nm to 35000 Nm

Complete spider kits with needle or roller bearing supported bushings are part of the delivery program of our cardan shaft service.



1. Installation and arrangement of universal drivelines

1.1 Basic installation rules

When a single universal-, cross- or ball joint is rotated uniformly in an angled position, a non-uniform motion occurs at the output side. (See motion characteristics and torques under 2).

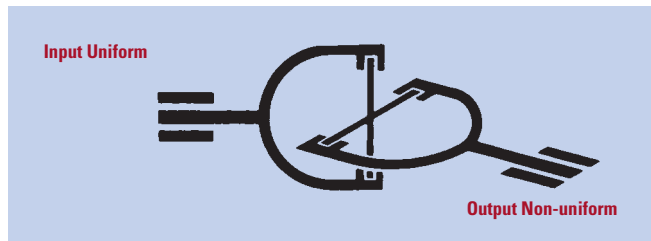

This fluctuation is eliminated when two single joints are connected, forming a driveline. To obtain complete synchronous motion, the following conditions must be met:

- a) Equal deflection angles at both joints ($\beta_1 = \beta_2$)
- b) The two inner forks must be in one plane.
- c) In- and output shaft must also lie in one plane.

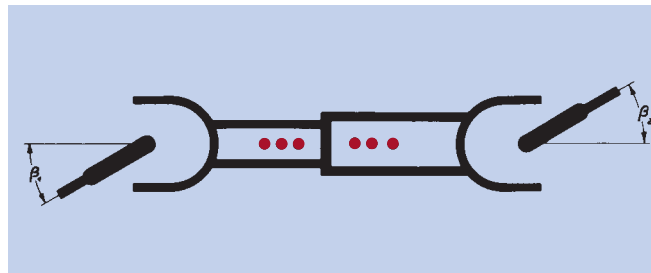

Exception:

If a driveline is angled three-dimensionally, in- and output shafts are not located in one plane. To obtain a uniform output motion, it is necessary in this case to offset the inner forks relative to each other so that they end up in the same plane of deflection created by their joints. Also, the three-dimensional deflection angles must also be equal. (Our Engineering Department will gladly assist you in determining the correct angular offset).

Note:

Incorrectly assembled universal joints do not equalize fluctuating output motion. They amplify it. This can lead to early joint bearing and spline failure. Therefore, when assembling the two driveline halves, the marker points on the spline shaft and spline sleeve must face each other.

The cross Journals and the needle bearing cups wear simultaneously. It is therefore necessary to replace both the cross and the needle bearings, if they show signs of wear.

1.2 Disassembly

1. Eliminate the tension between circlips and cups (see picture 1).
2. Remove circlips (with special pliers).
3. Press out one cup at each yoke (see picture 2).
4. Grip cup extending out of the yoke and pull them out (see picture 3). Use aluminium or plastic hammer.
5. Press out and pull off the opposite cup.
6. Remove cross (see picture 4).

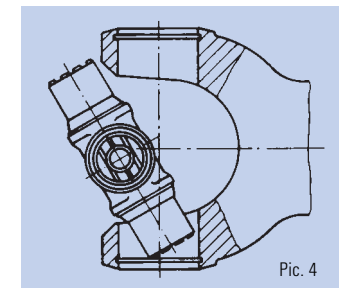
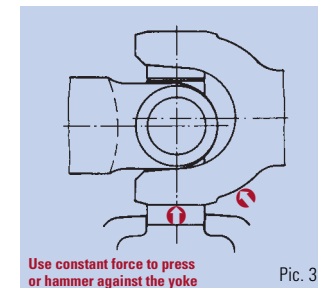
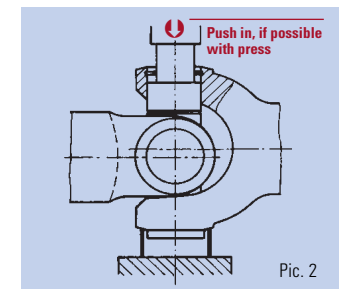
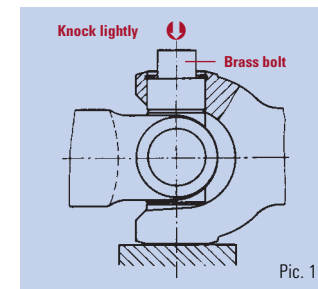

1.3 Assembly

1. Insert the cross (see picture 4).
2. Press in the bearing cup on one side and secure it with a circlip (see picture 5).
3. Press in and secure the opposite cup (see picture 6).
4. Insert the cross in the second yoke. Then press in the bearing cup and secure.
5. Tensions in the universal joint can be eliminated by lightly hammering against the yokes. The joint will then move more freely.

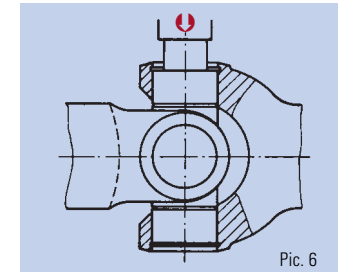
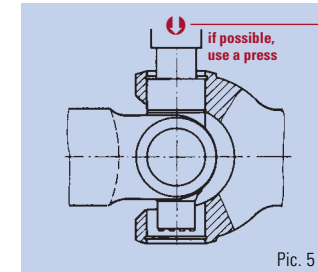

Instructions for Exchanging the Cross Assemblies in Double Joints for Steering Axles:

The bearing cups of the centre piece are fitted with a detaching thread. These cups can therefore be removed with a puller after removing the screw plugs. All other steps for assembling and disassembling are the same as described above.

Attention:

Before pressing in the bearing cups, make sure that all needles are in contact with the inside diameter of the cup. After replacing any worn parts, high-speed shafts must be rebalanced in accordance with rating Q16 of the VDI recommendations 2060. If the shaft is only subject to low speeds, rebalancing is not necessary. The speed limit lies between 500 and 800 rpm depending on size and design of the shaft. If, for any special reason, high-speed shafts cannot be rebalanced, the individual components of the yoke should be carefully marked before disassembling so that they can be realigned exactly after-wards. In this way the Unbalance can be limited to a minimum.

1.4 Arrangement configuration

Z-Configuration:

In- and output shaft are parallel to each other in one plane.

Requirement: $\beta_1 = \beta_2$

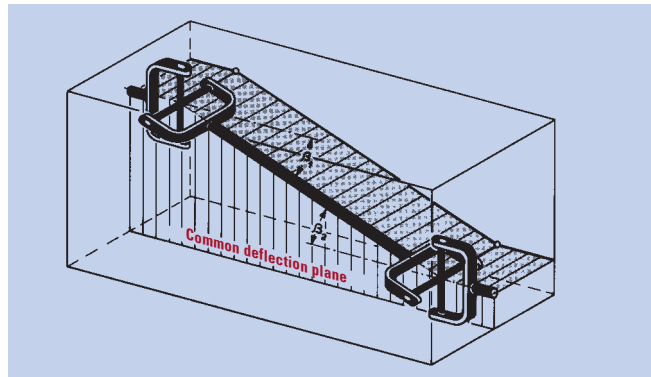

W-Configuration:

In- and output shaft intersect in one plane.

Requirement: $\beta_1 = \beta_2$

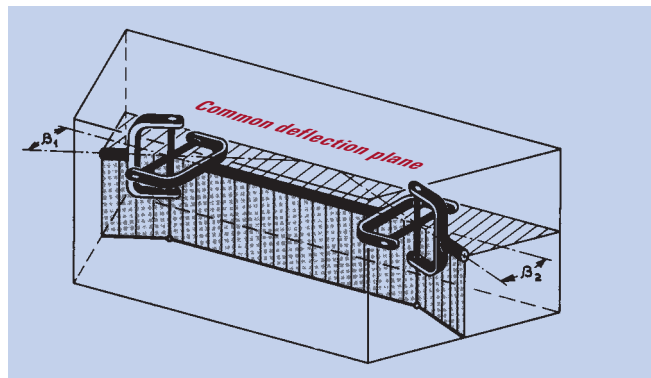

Three-dimensional configuration:

(Combined Z and W configuration)

In- and output shaft cross each other offset in space. No common plane exists. Therefore the inner forks must be offset by the angle γ (See 1.1 „Exception“).

Requirement: $\beta_{R1} = \beta_{R2}$

The resultant three-dimensional deflection angle β_R derived from the vertical and horizontal angular deviation, is calculated as:

$$\beta_R = \arctan \sqrt{\tan^2 \beta_v + \tan^2 \beta_h}$$

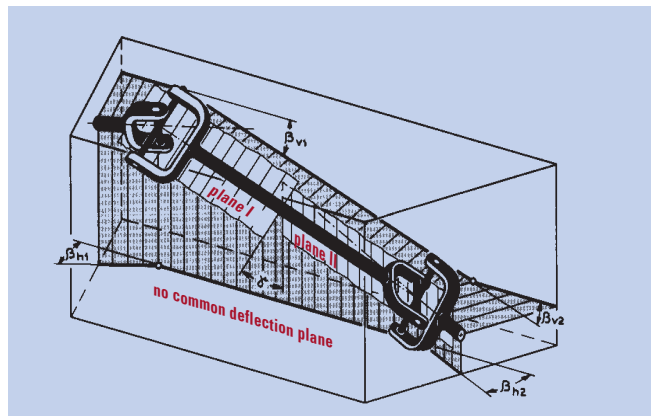

2. Motion relationships and torques

2.1 Rotation angle of a single joint as a function of deflection angle β

φ_1 = Input – rotation angle
 φ_2 = Output – rotation angle

If a single joint is deflected by angle β and rotated in this condition, rotation angle φ_2 of the output shaft differs from rotation angle φ_1 of the input shaft. The relationship between the two rotation angles is as follows:

$$\tan \varphi_2 = \frac{\tan \varphi_1}{\cos \beta}$$

As can be seen from the adjacent diagram, maximum lead occurs at about 45° , maximum lag at about 135° .

Fork position $\varphi_1 = 0^\circ$ is then obtained, when the input fork is located in the deflection-plane of the joint.

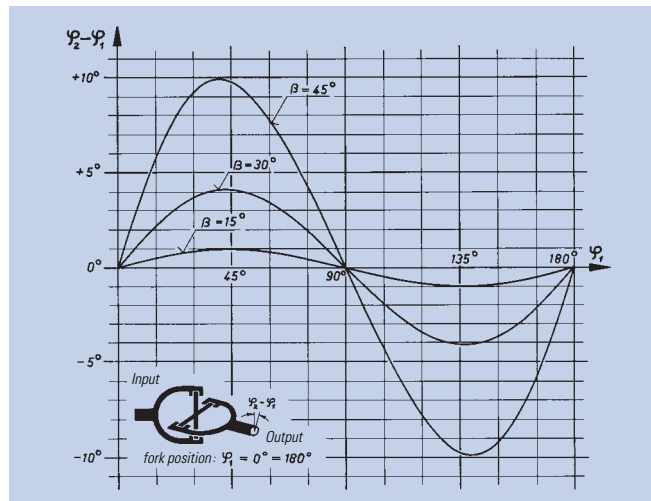

2.2 Motion and torque characteristics of a single joint as a function of deflection angle β

M_{dI} = Input torque
 M_{dII} = Output torque
 ω_I = Input – angular velocity
 ω_{II} = Output – angular velocity

When analyzing the motion and torque characteristic of a singular joint, it is found that with a constant angular velocity- and torque input, a fluctuating motion and torque curve is obtained at the output. The reason for this fluctuation can easily be illustrated by following the torque characteristic at the fork position $\varphi_1 = 0^\circ$ and $\varphi_1 = 90^\circ$ as shown at left. Since the torque can only be transmitted in the spider plane, the spider however, depending on the fork position, is always at a right angle to the input or output axis, output torque fluctuates twice per revolution between $M_{dI} \cdot \cos \beta$ and $M_{dI}/\cos \beta$.

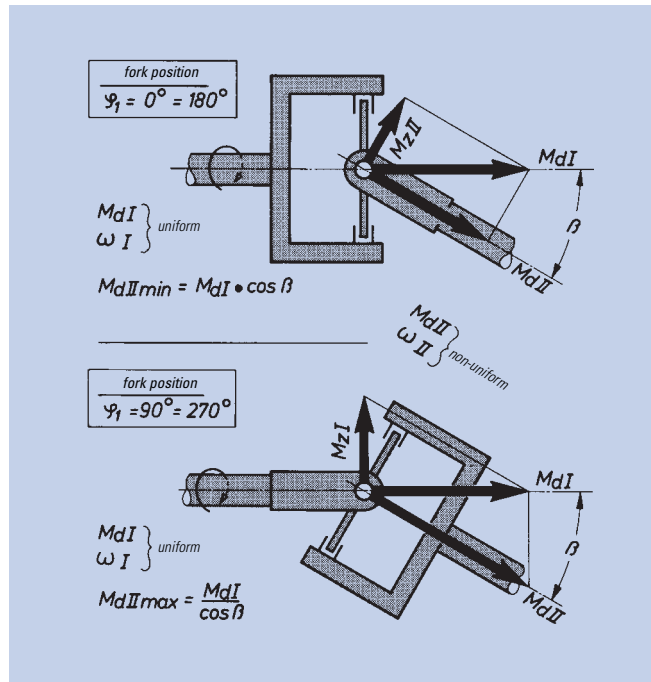

The transmitted power, however, is constant disregarding friction losses in the bearings.

Therefore, the following applies:

$$N_I = N_{II} = \text{Constant}$$

$$M_{dI} \cdot \omega_I = M_{dII} \cdot \omega_{II} = \text{Constant}$$

$$\frac{M_{dII}}{M_{dI}} = \frac{\omega_{II}}{\omega_I} = \frac{\cos \beta}{1 - \cos^2 \varphi_1 \cdot \sin^2 \beta}$$

For fork position $\varphi_1 = 0^\circ$ we obtain:

$$\frac{M_{dII}}{M_{dII \min}} = \frac{1}{\cos \beta} = \frac{\omega_{II \max}}{\omega_I}$$

and for fork position $\varphi_1 = 90^\circ$:

$$\frac{M_{dII}}{M_{dII \max}} = \cos \beta = \frac{\omega_{II \min}}{\omega_I}$$

$$\frac{M_{dI}}{M_{dII}} = \frac{\omega_{II}}{\omega_I} = \frac{M_{dII}}{M_{dI}}$$

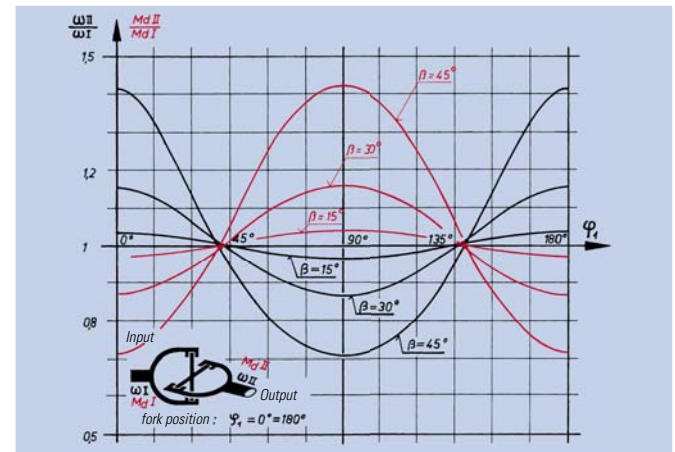

2.3 Motion and torque characteristic of a universal driveline as a function of deflection angles β_1 and β_2

Section 2.2 illustrates that angular velocity and torque at the output of a single joint follow a sinusoidal pattern with a 180° cycle. Maximum angular velocity $\omega_{II \max}$ coincides with minimum torque $M_{dII \min}$ and vice versa. From this can be derived that a non-uniform output is then possible, when a second joint, having a 90° phase shift is connected to

the first joint by means of a shaft. Then, the non-uniform motion of the first joint can be balanced by the non-uniform motion of the second joint. The required 90° phase shift is always then met, when the two inner forks happen to be in the deflection plane of their respective joints. Moreover, the two deflection angles β_1 and β_2 of both joints must be the

same. (See also Section 1.1 and 1.4).

With unequal deflection angles, complete compensation is not possible.

For $\beta_2 > \beta_1$, the following applies:

$$\left(\frac{\omega_{II \min}}{\omega_I} \right)_{\max} = \frac{\cos \beta_1}{\cos \beta_2}$$

$$\left(\frac{\omega_{II \min}}{\omega_I} \right)_{\min} = \frac{\cos \beta_2}{\cos \beta_1}$$

$$\left(\frac{M_{dII}}{M_{dI}} \right)_{\max} = \frac{\cos \beta_1}{\cos \beta_2}$$

$$\left(\frac{M_{dII}}{M_{dI}} \right)_{\min} = \frac{\cos \beta_2}{\cos \beta_1}$$

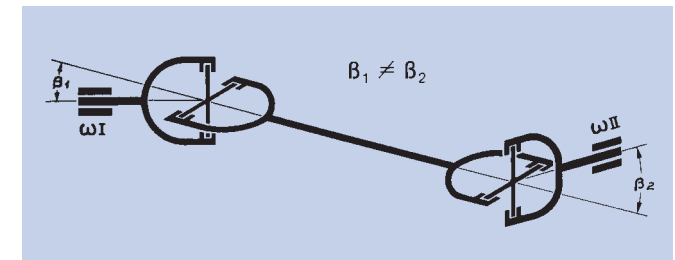

3. Fluctuation rate

3.1 Single joint

As explained under 2.1, on a single joint the output velocity deviates from the input velocity. This means, the speed ratio is not uniform. This non-uniformity (fluctuation) can be calculated as a dimensionless value:

Fluctuation rate

$$U = \frac{\omega_{2\max} - \omega_{2\min}}{\omega_1} = \frac{1}{\cos \beta} - \cos \beta$$

3.2 Universal driveline (2 joints connected in series)

If the preconditions listed in Chapter 1 for obtaining a complete motion compensation cannot be met, it must be aimed for that: $U \leq 0,0027$.

3.3 Universal driveline with more than two joints

Design requirements might dictate the use of a universal driveline that employs more than 2 joints. This universal driveline, however, must then incorporate an intermediate bearing.

Here, also, the condition applies:

$$U_{Res} \leq 0,0027.$$

Here, U_{Res} expresses the total fluctuation of the driveline.

Observe, when determining U_{Res} :

- a) Joints with the same fork position get the same sign.
- b) The fluctuation rate of each joint must be calculated individually U_1, U_2, U_3 .
- c) The signs must be observed when adding:

$$U_{Res} = \pm U_1 \pm U_2 \pm U_3$$

Since the rate of fluctuation is a function of deflection angle β , a limiting condition can be set in regard to the resulting deflection angle β_{Res}

$$\beta_{Res} = \sqrt{\pm \beta_1^2 \pm \beta_2^2 \pm \beta_3^2} \leq 3^\circ$$

β_{Res} corresponds to the deflection angle of a single joint if it were to replace the entire driveline.

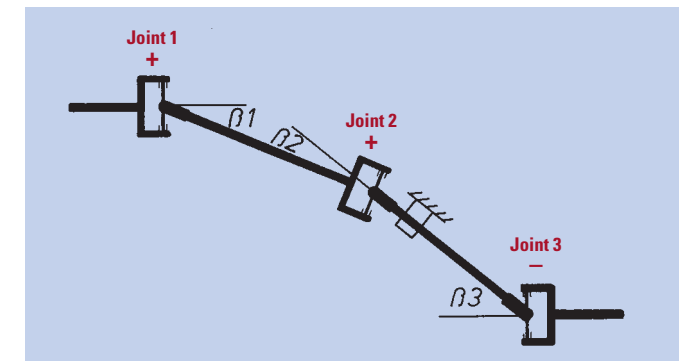

4. Offset angle

On drivelines with three-dimensional deflection angles, in- and output shaft are not located in one plane. This results, if no special measures are taken, in a non-uniform output motion. The constantly repeating acceleration and deceleration unleashes inertia forces which can greatly reduce the life of the joints.

However, not only the driveline, the driven equipment also is subjected to these forces and vibration caused by them. To avoid this, the inner forks must be offset relative to each other such that each fork ends up in the plane of deflection of its joint. The angle between both deflection planes is called offset angle γ

and it can be obtained as follows.

Example 1

$$\tan \gamma_1 = \frac{\tan \beta_{h1}}{\tan \beta_{v1}} ; \quad \tan \gamma_2 = \frac{\tan \beta_{h2}}{\tan \beta_{v2}}$$

Offset angle $\gamma = \gamma_1 - \gamma_2$

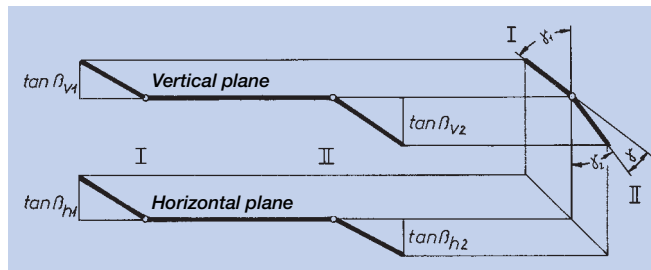

Example 2

$$\tan \gamma_1 = \frac{\tan \beta_{h1}}{\tan \beta_{v1}} ; \quad \tan \gamma_2 = \frac{\tan \beta_{h2}}{\tan \beta_{v2}}$$

Offset angle $\gamma = \gamma_1 + \gamma_2$

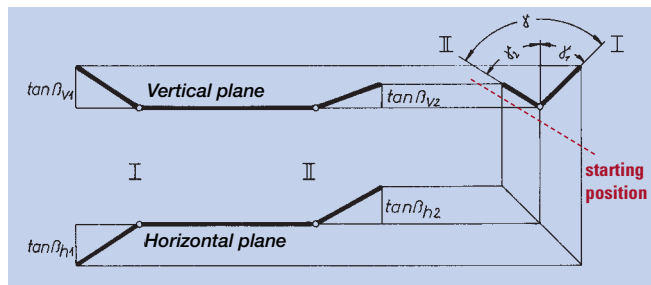

As shown by the graphic illustrations, on both examples two directions of rotation are possible:

Example 1:

- Rotate joint 1 counter clockwise by the offset angle
- Rotate joint 2 clockwise by the offset angle.

The direction for viewing is, in both cases, from joint 1 to joint 2.

Example 2:

- Rotate joint 1 counter clockwise by the offset angle
- Rotate joint 2 clockwise by the offset angle.

The direction for viewing is, in both case, from joint 1 to joint 2.

By researching the offset angle, you always have to take the graphic illustration. Only in this way it is possible to find the right direction of rotation and to determine whether the offset angle γ_1 and γ_2 have to be summed or have to be subtracted

5. Additional moments on the drive line Bearing loads on the in- and output shaft

In Section 2.2 it was shown that the torque is being transmitted only in the spider plane and that depending on the fork position, the spider can be perpendicular either to the input axis

or the output axis. What additional forces and moments this causes on the driveline as well as on the bearings of the in- and output shaft, is explained

briefly in the following chapter.

5.1 With Z-Arrangement

The adjacent illustration shows the location and direction of the additional forces and moments on drivelines having a Z-arrangement, in particular for yoke angles $\varphi_1 = 0^\circ$ and $\varphi_1 = 90^\circ$. This shows clearly, that the driveline center part is stressed by the torque which fluctuates between $M_{dl} \cdot \cos \beta$ and $M_{dl} / \cos \beta$ in torsion and by the additional moment M_{ZII} periodically alternating, in bending.

(See also Section 6.8).

Likewise, in- and output shaft are stressed by M_{ZI} and M_{ZIII} periodically alternating in bending. The resulting bearing load A and B vary twice per revolution between 0 and maximum value.

Bearing loads on in- and output shaft with Z-arrangement

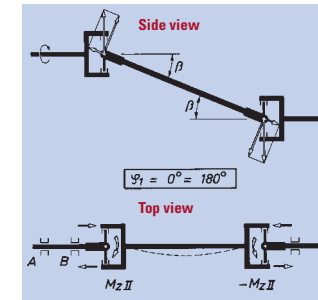

Driveline-center part stressed in bending

$$A = B = 0$$

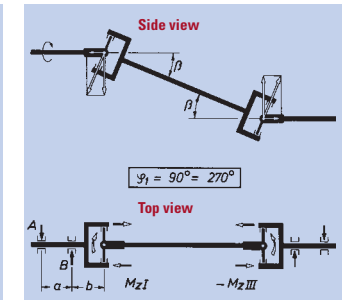

Driveline-center part stressed in bending

$$A_{\max} = B_{\max} = \frac{M_{dl} \cdot \tan \beta}{a} \quad [\text{N}]$$

5.2 With W-Arrangement

According to the adjacent illustration, with the W-arrangement, an additional force, "S" is introduced, caused by the additional moments M_{ZII} acting in the same direction. The maximum force value occurs at fork position $\varphi_1 = 0^\circ$, and it is being transmitted to the input- and output shaft by the faces of the spider pins.

Bearing loads on in- and output shaft with W-arrangement

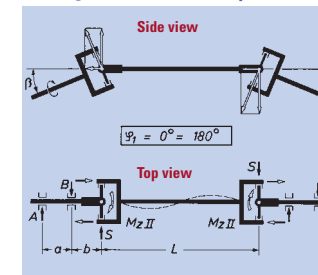

In- and output shaft stressed in bending

$$A = \frac{2 \cdot M_{dl} \cdot \sin \beta \cdot b}{L \cdot a} \quad B = \frac{2 \cdot M_{dl} \cdot \sin \beta \cdot (a+b)}{L \cdot a}$$

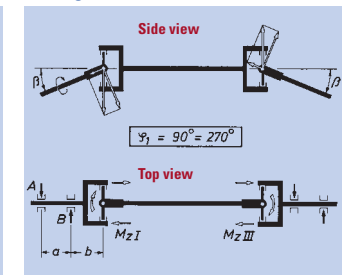

In- and output shaft stressed in bending

$$A = B = \frac{M_{dl} \cdot \tan \beta}{a} \quad [\text{N}]$$

5.3 Caused by axial displacement forces

If a driveline with an adjustable spline is being changed in length while under torque, in both cases, Z- or W configuration, addition bearing loads are introduced, resulting from the friction caused in the spline. The axial displacement force Pa responsible for these bearing loads is calculated as follows:

placement force Pa responsible for these bearing loads is calculated as follows:

$$P_a = 2 \cdot M_{dl} \cdot \mu \left(\frac{1}{d_m} + \frac{\sin \beta}{\dot{U}} \right) \quad [\text{N}]$$

d_m is the spline pitch diameter, \dot{U} the spline

overlap. Depending on configuration and lubrication, the coefficient of friction for steel on steel must be assumed to range from 0.11 to 0.15. Plastic coated splines have considerably better sliding characteristics. Here, the friction value is approximately 0.08. Rilsan coated splines are available from size 0.109 up.

6. Fundamental data for sizing of universal drivelines

To size universal drivelines properly, various conditions and factors must be considered. In view of the multitude of possible applications, exact, generally valid rules cannot be

provided. The following information is therefore used for the first rough determination of size. In case of doubt, we will gladly compute the required joint sizes for you and, in this

context, we like to refer to the technical questionnaires starting on page 189.

6.1 Torques

The max. permitted torques $M_{d,max}$ stated for the individual drive-shaft sizes apply normally only for short-term peak loads.

$M_{d,nom}$: Nominal torque for pre-selection on the basis of the operating moment.

$M_{d,lim}$: Limit torque that may be transmitted temporarily from the universal-drive-joint at limited frequency without functional damage.

The respective permissible torque has to be calculated individually depending on the remaining operating data, such as shock loads, angle of deflection, rotation, etc. (See item 6.2 and 6.3)

6.2 Shock loads

Depending on the type of power input or installation, a driveline can be subjected to shock loads considerably above the rated torque. To take those into account, shock service factors must be implemented. Following are some shock-service factors for the most common drives

Prime mover	with flexible coupling	without flexible coupling
Turbine or electric motor	1	1 to 1,5
Gasoline engine, 4 and more cylinders	1,25	1,75
Gasoline engine, 1 to 3 cylinders	1,5	2
Diesel engine, 4 and more cylinders	1,5	2
Diesel engine, 1 to 3 cylinders	2	2,5

Of course, not only the drives, but, in many instances, also the driven equipment is responsible for shock loads. Because of the magnitude of different possibilities, general data valid for every use cannot be supplied.

6.3 Life expectancy – calculation

The decisive factor with regard to life expectancy of universal drivelines are usually the joint bearing. Therefore, in order to determine the individually required joint size, the life expectancy diagram shown later on should be used. This diagram allows to:

- determine the theoretical life expectancy of a selected driveline as a function of prevailing operating conditions, or
- determine the required joint size for a given life expectancy.

In this case, the rated input torque is multiplied by the appropriate service (shock) factor and the M_d such obtained entered in the following diagram. Other factors, such as correction - or deflection angle factor do not have to be considered since they are already incorporated in the diagram.

On machines or vehicles with changing operating conditions, at first, the individual life expectancy values (for each condition) must be determined from the diagram. Then the overall life expectancy L_{hR} can be calculated as follows:

q_1, q_2, \dots = time share in [%]
 L_{h1}, L_{h2}, \dots expressed in 10^3 [Hours]

$$L_{hR} = \frac{100\,000}{\frac{q_1}{L_{h1}} + \frac{q_2}{L_{h2}} + \dots + \frac{q_n}{L_{hn}}} \text{ [Hours]}$$

6.4 Life expectancy-Diagram

In view of the multitude of applications, it is not possible to determine the suitability of a driveline by tests. Therefore, the selection and analysis of the required joint size is done by calculations. These are based on the computation of the dynamic load carrying capacity of full rotation needle - and roller bearings according to ISO recommendation R 281. The life expectancy diagrams shown in the catalogue are based on this recommendation and also on an equation formula especially suited for obtaining nominal life expectancy on universal joints. The thus obtained life expectancy lists the hours of operation that will be reached or exceeded by 90% of a larger number of equivalent universal joint bearings.

There are also methods of obtaining the modified life expectancy. In this case varying survival probabilities, material quality and operating conditions are taken into account. The present technical know how does not allow statements to be made about variations in life expectancy-performance resulting from differences in steel quality (grain, hardness, impurities). For this reason, no guidelines have been set in the International Standards.

All pertinent operating conditions, such as operating temperature, lubrication intervals, the type of grease used and its viscosity in operation, must also be considered. Since these factors vary from case to case, it is not possible to determine the modified life

expectancy and accordingly, a life expectancy diagram valid for universal use.

The two following life expectancy diagrams will allow you to roughly determine the nominal life expectancy.

If the deflection angle is smaller than $\beta = 3^\circ$, $\beta = 3$ should be used. Otherwise, the obtained result will be less accurate.

If it is necessary to determine the life expectancy accurately, kindly consult the ELBE Engineering Department.

6.5 Life expectancy diagram, Needle bearing

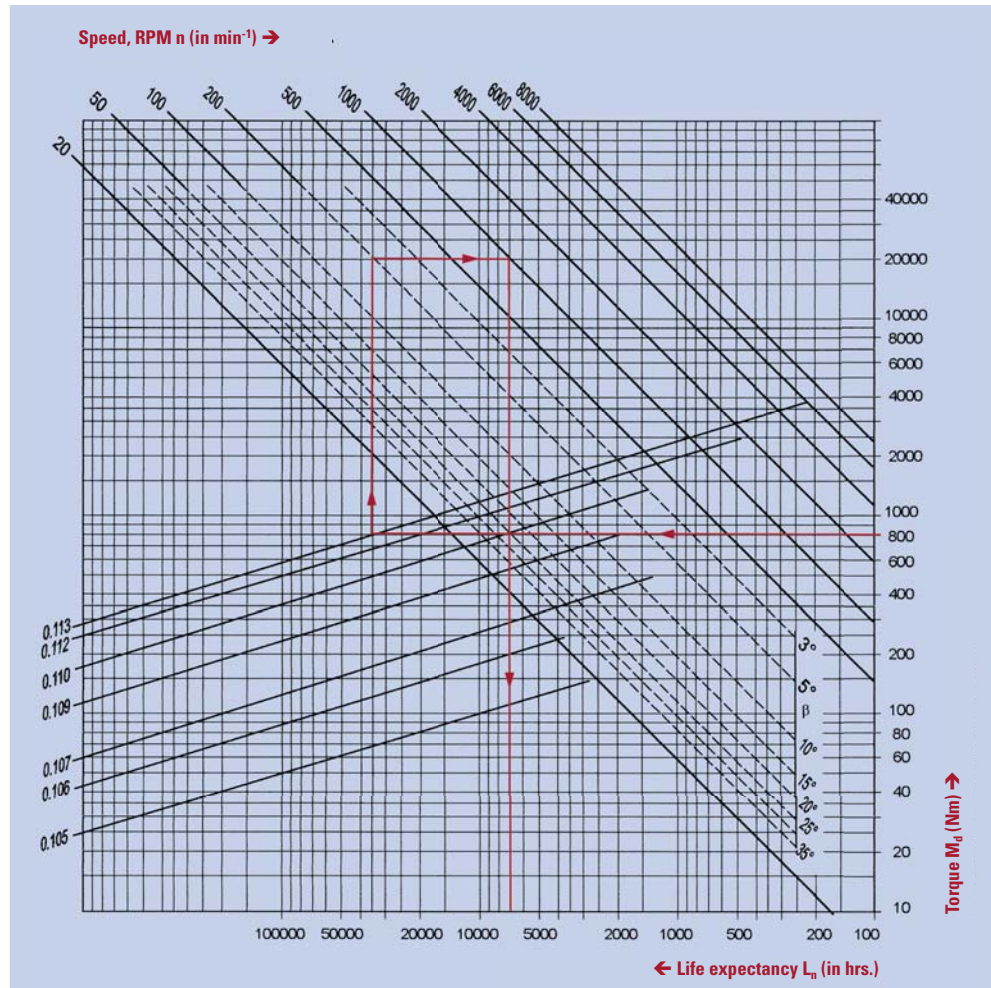

Example
 Universal driveline 0.113
 Torque $M_d = 800 \text{ Nm}$
 Deflection angle $\beta = 5^\circ$
 RPM $n = 1000 \text{ min}^{-1}$



Life expectancy = 6900 hrs.

Procedure:
 Torque \rightarrow Joint size \rightarrow Deflection angle \rightarrow RPM \rightarrow Life expectancy

6.6 Life expectancy diagram, Roller bearing

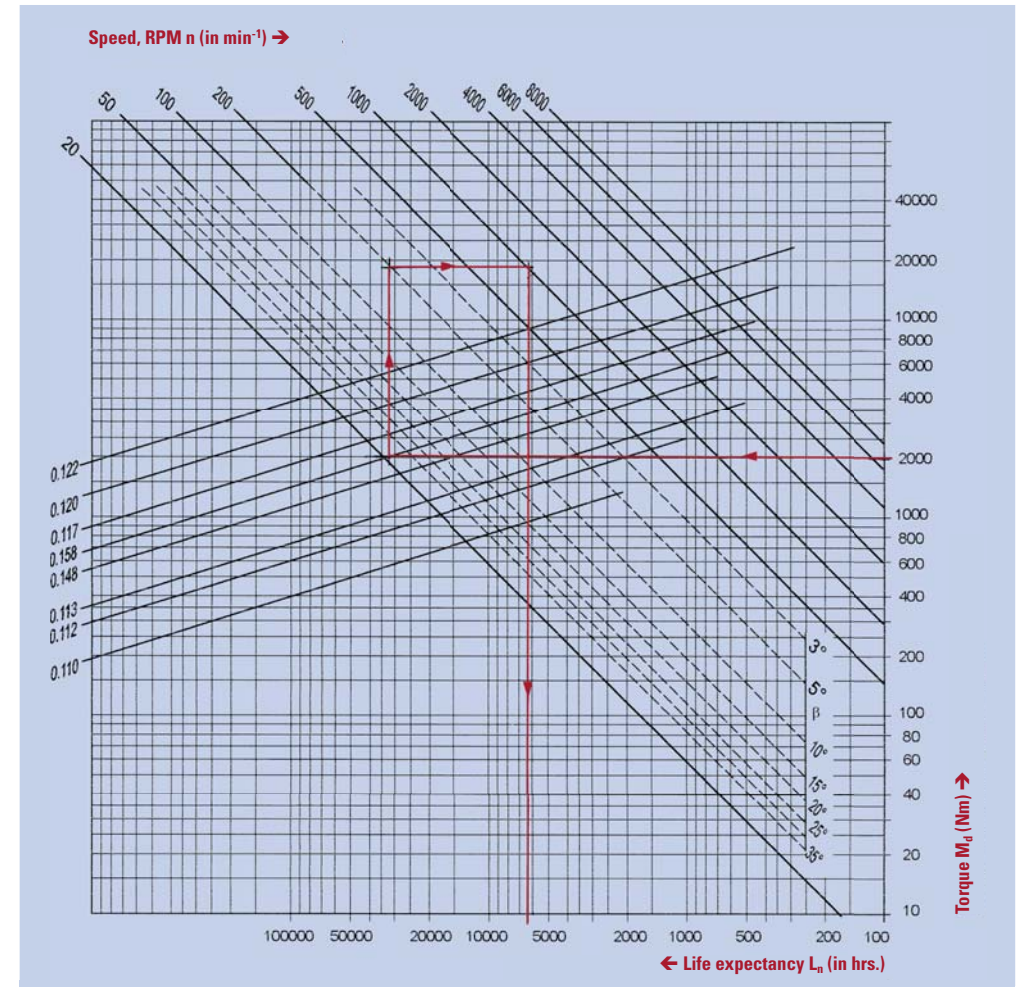

Example
 Universal driveline 0.158
 Torque $M_d = 2000 \text{ Nm}$
 Deflection angle $\beta = 5^\circ$
 RPM $n = 1000 \text{ min}^{-1}$



Life expectancy = 7000 hrs.

Procedure:
 Torque \rightarrow Joint size \rightarrow Deflection angle \rightarrow RPM \rightarrow Life expectancy

6.7 RPM and deflection angle

As shown in 2.3 by taking certain precautions, a constant output can be obtained on a universal driveline. The center part, however, still retains a non-uniform motion; it is subjected twice per revolution to an acceleration and deceleration. The resulting acceleration torque caused this way is a function of the mass moment of inertia of the driveline's

center part as well as of rpm and deflection angle. When regarding smoothness of operation and wear, the product of rpm and deflection angle should not be too high. For use in general mechanical engineering, appropriate guide values can be taken from the diagram below, which is designed for universal drivelines having a standard tubing of up

to 1500 mm length. For vehicle drive trains, these guide values must often be exceeded. Here, at most, up to 1.5 times of the diagram value can be permitted.

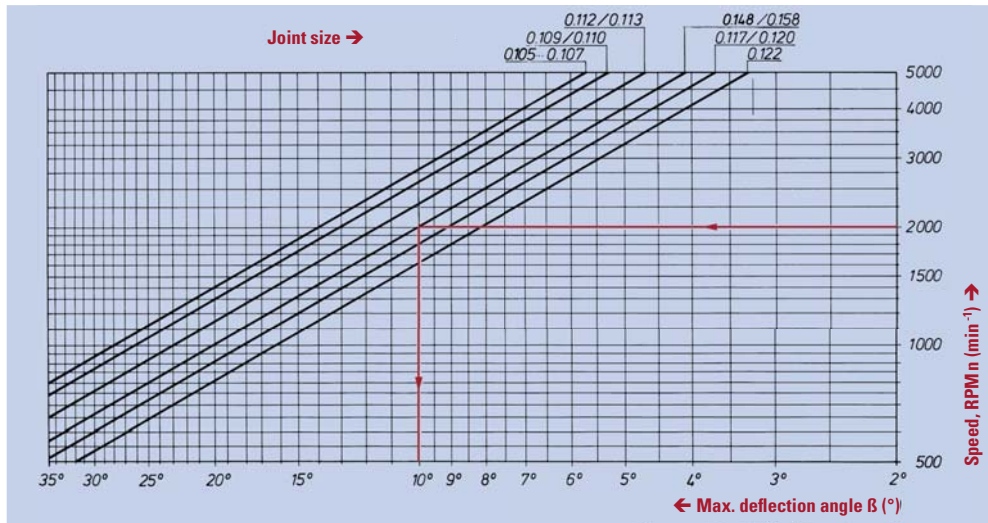

6.8 Critical speeds

As shown in 5.1, the center part of the angled driveline, when transmitting torque, is being stressed periodically in bending by additional moment M_{Z1} . This incites the center part to vibrate. If the frequency of this bending vibration approaches the natural frequency of the driveline, maximum stress in all components, buckling of the shaft and development of noise will result.

To avoid this, long and fast running drivelines must be checked for critical bending vibration speeds. The critical, first order bending vibration speed of a driveline employing tubing can be roughly calculated as follows:

$$n_{kr} \approx 1,21 \cdot 10^8 \frac{\sqrt{D^2 + d^2}}{L^2} \quad [\text{min}^{-1}]$$

D = Tubing-outside diameter [mm]
d = Tubing-inside diameter [mm]
L = Center part length in [mm]

Drivelines are used in the subcritical zone only. For reasons of safety, it must be ensured that the maximum operating speed is far enough away from its system's resonance (critical) speed. Therefore, the following applies:

$$\text{Max. Operating Speed } n_{\text{max}} \approx 0,65 \cdot n_{\text{cr}} [\text{RPM}]$$

6.9 Larger tubing diameters

The critical bending vibration speed of a driveline is, as can be seen from the critical rpm formula, a function of tubing diameters and length of center part. By going to larger tubing diameters, the critical speed of a driveline can be increased. However, the diameter increase must remain within defined limits since a certain relationship between tubing dimensions and joint size must be adhered to.

The dimension sheets of the different driveline models list the possible tubing dimensions for each size. In all the cases where a single driveline is insufficient, multiple arrangements with intermediate bearings must be used.

It must be noted that larger tubing diameters are feasible only above a certain shaft length. The following minimum lengths can be used as a guide line.

Flange diameter [mm]	Up to 65	75 to 100	120 to 180
Min. length S [mm]	650	950	1250

6.10 Tubing diagram

For determining the required tubing diameter when maximum operating speed n_{max} and center part length L are given.

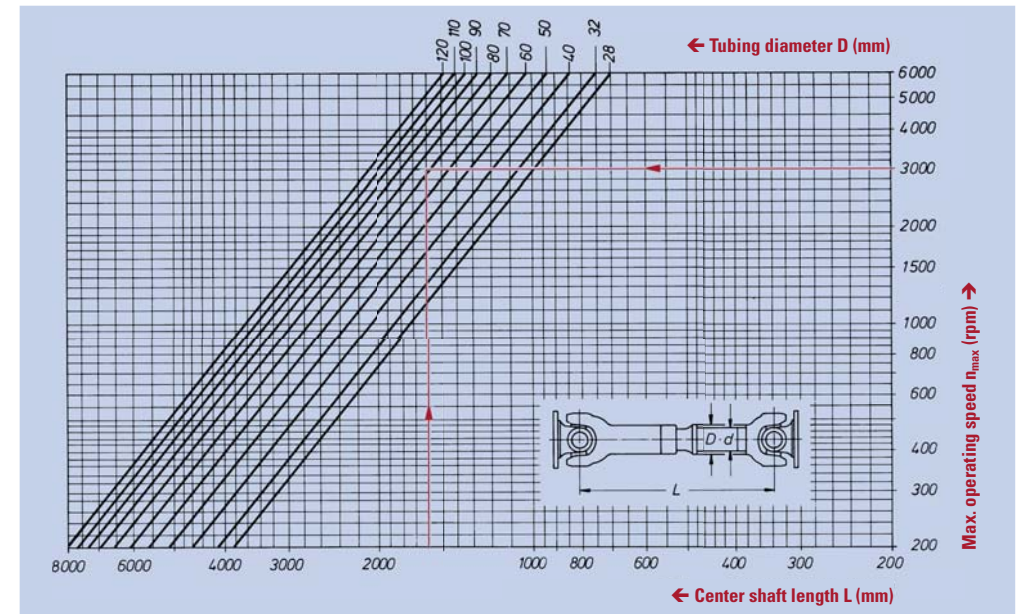

Example:

Center shaft length L = 1600 mm
Max. operating speed $n_{\text{max}} = 3000$ RPM } Obtained: Tubing diameter ≥ 70 mm

7. Application principles for double joint shafts in steering axles

The double joint shafts of series 0.400.5 and 0.500.3 are intended for use in powered steering axles only.

7.1 Kinematic conditions

As shown in the sketch below, when steering is activated, the axle system is rotated around pin center **D**. The double joint deflects at its two joint pivot points **A** and **B**. Since shaft II is fixed axially, shaft I must move in the direction **S**. This causes unequal joint deflection angles β_1 and β_2 , and therefore, also a non-uniform (fluctuating) output motion. The fluctuation can be kept very small provided joint center **C** is offset toward the fixed side by the

compensation value **X**. This way, at a certain deflection angle (= synchronous motion angle β_x) completely uniform motion is obtained, i.e., the two joint deflection angles β_1 and β_2 are equal.

$\beta_x = 30^\circ$ bis 35° would be an appropriate synchronous motion angle to select

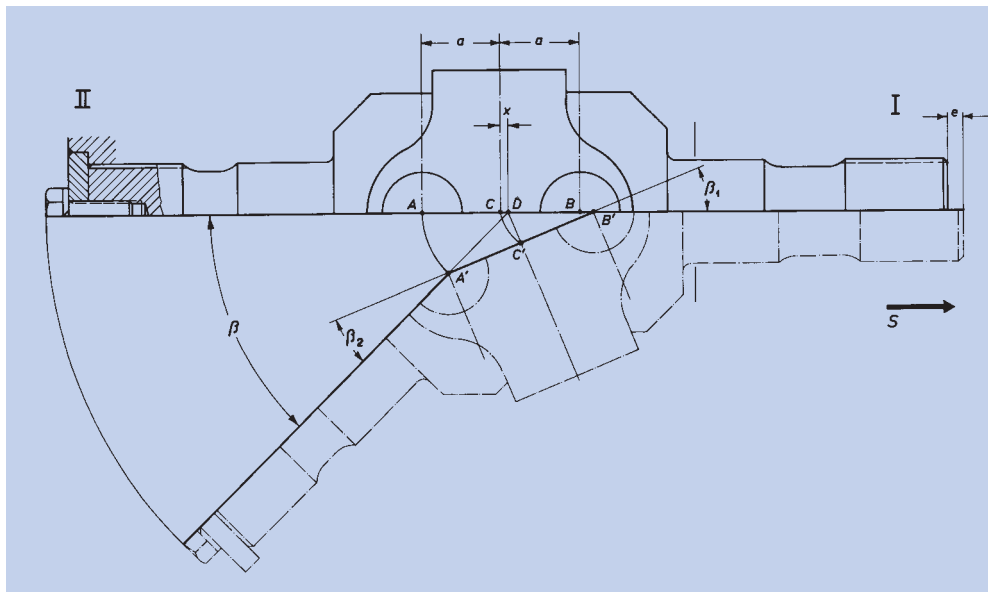

- A } Joint pivot point
- B } Joint pivot point
- C = center of the double joint
- D = rotation pin center
- a = distance of a joint point from the center of the double joint
- e = axial movement of floating shaft
- X = center offset on installation
- β_x = uniform motion angle (synchronous)
- β = total deflection angle
- β_1 } deflection angle of each individual joint
- β_2 }

7.2 Center offset value **x** and max. slide movement **e**

$$X = \frac{a}{\cos \frac{\beta_x}{2}} - a$$

The center offset **X** required for smooth output can be derived from distance **a** and synchronous motion angle β :

Calculated center offset value **X** for individual joint sizes:
Series 0.400, synchronous motion angle $\beta_x = 35^\circ$

Joint size	0.408	0.409	0.411	0.412
Deflection angle β°	50	50	50	50
x [mm]	1,5	1,7	2,0	2,2

Series 0.500, synchronous motion angle $\beta_x = 32^\circ$

Joint size	0.509	0.510	0.511	0.512	0.513	0.515	0.516	0.518
Deflection angle β°	42 47	50	42 47	42 47	42 47	42 47	42 47	42 47
x [mm]	1,3 1,3	1,6	1,5 1,6	1,6 1,7	1,7 1,8	1,9 2,0	2,1 2,2	2,2 2,3

Sliding motion **e** at deflection angle β , and also as a function of distance **a** and uniform motion angle β_x , can be calculated as follows:

$$e = 2a \left(\frac{\sin^2 \frac{\beta}{2} + \sqrt{\cos^2 \frac{\beta_x}{2} - \sin^2 \frac{\beta}{2} \cdot \cos^2 \frac{\beta}{2}}}{\cos \frac{\beta_x}{2}} - 1 \right)$$

Max. slide motion **e** for the individual joint sizes:
Series 0.400, synchronous motion angle $\beta_x = 35^\circ$

Joint size	0.408	0.409	0.411	0.412
Deflection angle β°	50	50	50	50
e [mm]	6,5	7,2	8,3	9,2

Series 0.500, uniform synchronous motion angle $\beta_x = 32^\circ$

Joint size	0.509	0.510	0.511	0.512	0.513	0.515	0.516	0.518
Deflection angle β°	42 47	50	42 47	42 47	42 47	42 47	42 47	42 47
e [mm]	4,5 6,0	7,9	5,2 6,9	5,8 7,8	6,1 8,1	6,7 9,0	7,3 9,7	7,8 10,5

7.3 Sizing of double joint shafts

Max. possible torque should be used for determining the required joint size. This could be the input torque, calculated from prime mover output, gear ratio and power distribution, or also the tire slippage torque, derived from allowable axle loading, static tire radius and coefficient of friction. The lower of the two values represents the maximum operating torque which should be used for determining the

proper joint size. The double joint shaft selected this way will have adequate life expectancy, since the time percentage of maximum loading is usually low.

7.4 Loads on the shaft bearing

Double joint shafts, when not centered, must have a bearing support at both shaft halves right next to the joint with one shaft half fixed axially and the other floating axially. When torque is being transmitted, additional forces occur which must be taken into account when sizing the bearings.

7.5 Torque capacity of double joints as a function of deflection angle

Under torque, different force conditions exist at the joint spider pins and center piece with the double joint in an angled position than in a straight position. The reason for this is that the torque to be transmitted is not distributed evenly over the joint spider pins any longer. Also, as mentioned in Chapter 5, an additional moment occurs. This additional moment must be combined with the torque to be transmitted.

This resulting moment leads to higher compression loads and to a larger bending stress within the joint spider pins. The diagram below allows to take these factors into account. It shows the percentage the maximum allowable torque must be reduced in relation to the deflection angle.

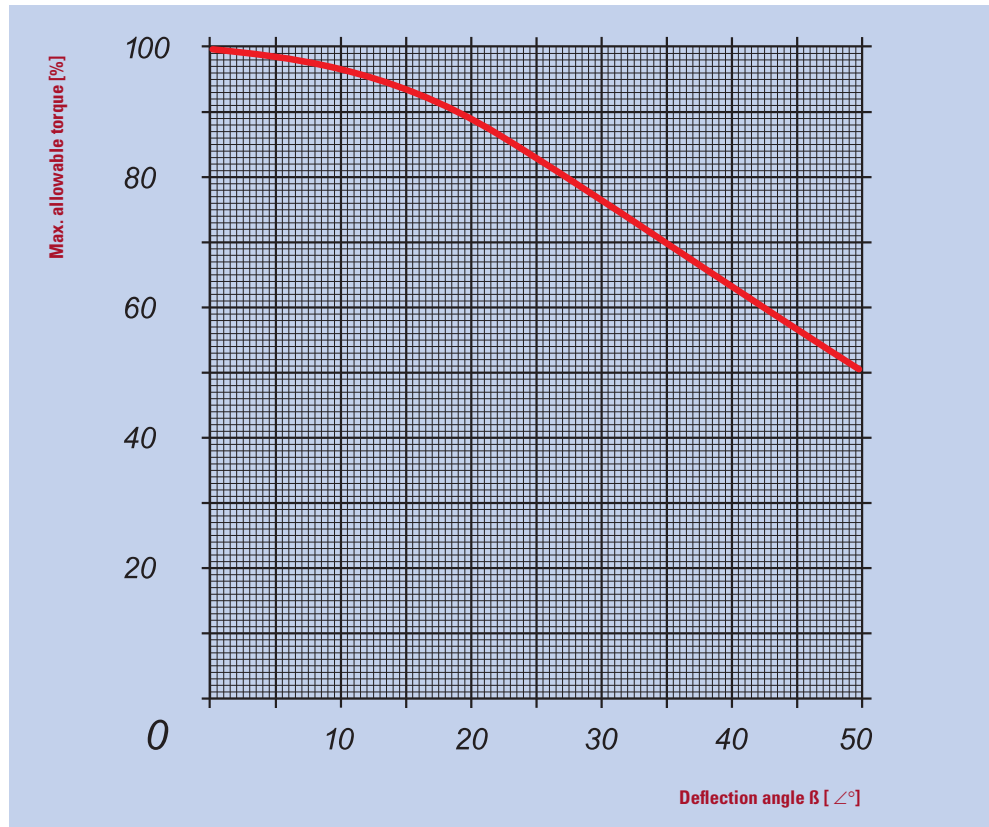

8. Hints for the application of pin and block cardan joints, ball and socket cardan joints

Torque calculation for needle bearing equipped precision cardan shafts, pin and block cardan joints, ball and socket cardan joints, single

The values $M_{d,max}$ listed in the diagram represent limit values that may not be exceeded. They are admissible in full altitude only at small rotation speed and minor angle of deflection respectively at intermittent duty.

The transmissible torque varies depending on the size of the angle of deflection.

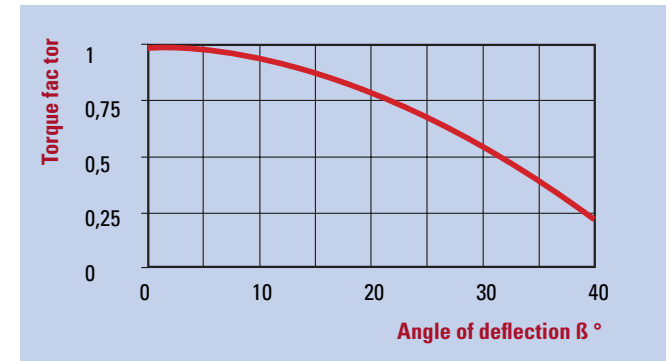

Needle bearing equipped precision cardan joints

Permitted max. operation moments of the needle bearing equipped precision cardan joints (Torque in Nm).

Joint type	Speed (r.p.m.)						
	250	500	1000	2000	3000	4000	5000
0.616	11	10	8	6	5,5	5,1	4,8
0.620	28	25	19	15	14	12,5	12
0.625	35	30	25	20	18,5	17	16
0.632	70	60	50	40	37	34	32
0.640	150	130	100	80	74	68	64
0.650	220	190	150	120	110	100	95
0.663	450	400	310	250	220	200	190

Pin and Block cardan joint, Ball and socket cardan joint, single

The empirical formula on the right can be used for the rolled calculation of the required joint size.

A_t	$M_{d,max}$	Speed x bending angle ≤ 500
A_t	$0,5 \times M_{d,max}$	Speed x bending angle ≤ 5000

9. Transport and storage – installation information

Our universal drivelines are delivered ready for installation. If not otherwise specified by the customer, they are balanced dynamically at $n = 2000$ RPM according to classification Q 16 of the VDI recommendation 2060.

9.1 Transport and storage

To retain the high degree of balance, the drivelines must be protected during transportation or storage from blows or jolts. It is recommended to transport them in horizontal position. When transporting them vertically, appropriate measures must be taken to avoid separation of the driveline halves. A horizontal position is also preferred for storage of the driveline, since doing so eliminates tipping over and possible damage. Never store drivelines on the floor, but if possible, on wooden shelves. At prolonged storage, blank metal parts must be checked for corrosion, and if necessary, treated again with a corrosion inhibiting oil.

9.2 Installation

Before installing drivelines, all traces of rust inhibitor, dirt and grease must be removed from the flange surfaces to preserve the coefficient of friction vital for torque transmission.

Drivelines should not be separated at the splines and the halves interchanged, otherwise the quality of balance is greatly impaired. For the same reason, balance plates should not be removed.

Prior to installing drivelines, it must be checked that they are assembled correctly, which means that the marking arrows on the splined shaft and splined hub must face each other (See also notation on Page 170).

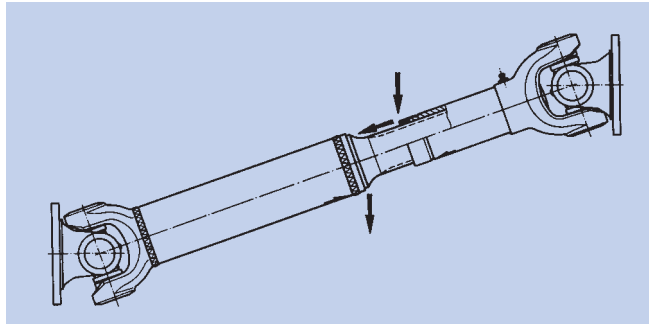

This drivelines should be arranged such that the spline, whenever possible, is protected from dirt and moisture. As a rule, this means installing the driveline according to the sketch

above, where the spline seal points downwards so that spray water hitting it runs away from the spline.

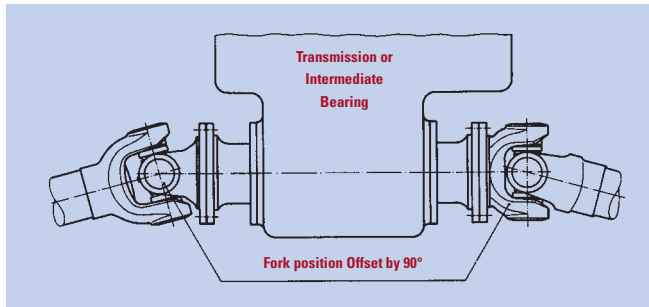

If two or more drivelines are arranged in series behind each other, it is recommended that they be mounted offset to each other by 90° . Doing so will at least partially cancel to the outside the effect of the mass acceleration forces caused by the fluctuation motion of the driveline center parts.

The necessary, bolting hardware for flange mounting can also be supplied by us on re-

quest. For bolt grades and necessary bolt torque, see page 74. When torquing down the bolts, if possible, a torque wrench should be used and the torque should be applied evenly in a crosswise pattern.

Our drivelines are delivered grease-packed, ready for installation. However, after prolonged storage, it is advisable to reapply grease before putting them into service.

10. Safety instructions and Maintenance

10.1 Safety instructions

The operator has to take corresponding safety precautions that will exclude dangers to persons and material by rotating drive shafts or their components.

- On working on the drive-shafts the **drive has to be in quiescent condition** – set down engine and secure, so that the drive can't be activated unauthorised by a third person.
- Installation, assembly and maintenance work may be performed only by **competent personnel**.
- When installing and disassembling and when transporting of the drive shafts don't reach into the joints to avoid contusions caused by **tilting flanges or components**. Take suitable measures to avoid that drive-shafts-shares **slide apart unintentionally** and cause injuries or damage.
- Fast mode or/and long shafts should be lined with protection devices like safety shackle and guard and protected against touching or point potential dangers explicitly out.
- Don't place weights onto shafts in standstill, don't place, hang or fasten tools or other objects on the shafts.

The user or operator has to observe the legal safety regulations and has to make arrangements before beginning the maintenance-work.

To avoid damages or dangers observe the following **basic information**:

- The permitted **operating speed** may not be exceeded.
- Don't exceed the permitted **angle of deflection**.
- In case of shafts with **length extension** the maximum permitted X-value may not be exceeded. It is recommended to use 1/3 of the complete length extension.
- The drive shaft has to be checked regularly for modified **running noises and vibrations** and if necessary to check the changing of the **joint slackness** and of the length extension in standstill.
- The **balance status** of drive shafts may not be changed.
- Don't make modifications or unauthorized repairs without the **written approval** of the manufacturer, as dangers for humans and material result and any claim of warranty becomes void.

- Drive shafts may not be cleaned with **pressure water** or **steam jet** to avoid damage of the seals and to prevent the penetration of water and dirt.
- When cleaning don't use **aggressive cleanser**.
- **Protect plastics-coated profiles** and sliding surfaces against mechanical, thermal and chemical damages. Sliding surfaces for seals have to be covered before colouring.
- The drive shafts may only be installed in fluid or solid media with written approval of the manufacturer.
- **Local heating** of the drive shafts (e. g. flame cleaning of colour residues) must not be carried out to avoid significant changes of the true running characteristics.

vals of the machine or of the vehicle.

Inspection and maintenance are required at least once a year.

10.2 General maintenance information

ELBE drive shafts will be delivered as fully finished power units, are ready for use greased and balanced. To guarantee the characteristics specified in the documentation the condition upon delivery may not be changed.

Above-average load, variations in temperature and the effect of dirt and water render it necessary to observe shorter maintenance intervals to guarantee the safe and efficient application.

The maintenance-cycle of the drive shafts depends particularly on the application conditions.

We recommend coordinating the inspection intervals of the drive shafts with the ones of other machine parts or with the service inter-

Application field	control and maintenance intervals Joint	length extension
Commercial vehicles in street application	50.000 km or 1 year	maintenance-free
Commercial vehicles in street- and territory application	25.000 km or 6 months	maintenance-free
Commercial vehicles in pure construction-site and territory application	10.000 km or 1 month	maintenance-free or 100 hours
Earth-moving and construction machines	250 operating hours or 1 month	maintenance-free or 100 hours
Stationary plant and machines construction	500 operating hours or 3 months	maintenance-free or 3 months

10.3 Lubrication guidelines

ELBE cardan-drive-shafts are normally equipped with 3 cone-grease-nipples DIN 71412. Thereby every joint will be greased over per grease nipple, the third nipple serves for relubrication of the spline profile.

This nipple is omitted for plastic-coated length extensions.

10.3.1 Lubricants

- Temperature range -30°C up to max. +100°C. For relubrication of the drive shafts use only **lithium-saponified greases** of consistency class 2 with penetration 265/295 and drop point approx. 180°C. The lubrications may not contain **MoS2**-additives.

- Temperature range up to approx. +160°C, temporary up to 180°C (**High-temperature-version**): use HT-greases of the consistency 1 or 2. Special versions up to +250°C are partly also available.
- Temperature range from approx. -60°C up to +110°C (low-temperature-version): use TT-greases of the consistency 1 or 2.

- **Low-maintenance or maintenance-free**: If longer lubrication-periods are required, low-maintenance versions of the drive shafts are available. In consideration of the application conditions if necessary maintenance-free versions are also available. Consult our technical service team.

10.4 Technical information

- Before lubricating **clean grease nipples!**
- The relubrication of the spline-length-extension should be carried out **at compressed length** S_{min} or in the shortest operation status (vehicle loaded). Non-observance may result in excess axial forces.
- Air vent may not be taken off or be replaced by standard grease nipples.
- The lubricant may not be pressed in with excessive pressure or with hard lubrication impact.

- Max. permitted **lubrication pressure: 20 bar**.
- The cross units have to relubricatd over the grease nipples in the centre of the cross or on the bottom of a bearing housing of the cross. It must be ensured that grease has to be pressed in until it **leaks from all four seals of each bearing**.
- This is the only way to ensure that all four bearings have received fresh grease.

- Some versions of double drive-shafts are equipped with a grease nipple on the centre piece of the joint, over which both cross joints can be relubricated at the same time through lubrication ducts (**central lubrication**).
- Drive shafts that are stored more than 6 months have to be lubricated before starting.

10.5 Control information

- Fittings and connection flanges have to be checked for firm connection.
- Drive shafts should be checked in operation for abnormal noises or vibrations, to determine the cause and initiate repair work.
- Before lubrication, check the driveshaft for looseness in the joints or splines.

- The connection side of the drive shaft flanges and companion flanges must be cleaned before installation. They must not be greased or oiled.
- Corrosion inhibitors and paint residues must be thoroughly removed. Possible light transportation damage should be corrected (knicks and scratches).

- Companion flanges have to be checked for face and OD roundout.